



SUSTAINABLE BESPOKE TIMBERS - COMMERCIAL & RESIDENTIAL



WWW.NZNATURALTIMBER.CO.NZ
SALES@NZNATURALTIMBER.CO.NZ
-
PHONE +64 27 660 0095

SHOWROOM
10/68 MARSDEN
BAY DRIVE,
NORTHLAND,
NEW ZEALAND

FULL SERVICE

Profiles

Architectural Profile Drawings

Document Code: 200423

- Decking
- Flooring
- Fascia
- Weatherboards
- Panelling / Sarkings
- Mouldings

Decking

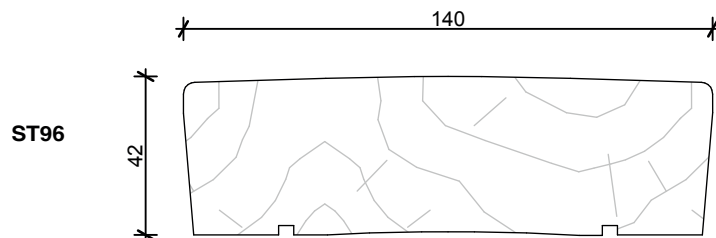
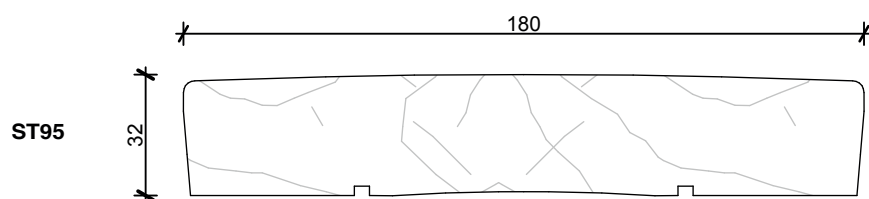
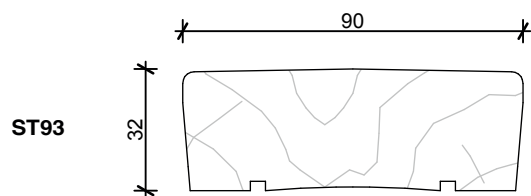
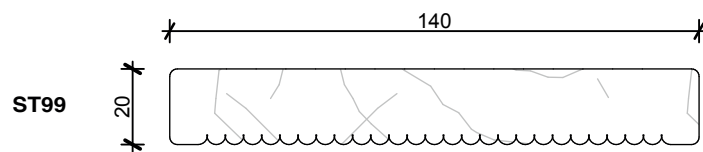
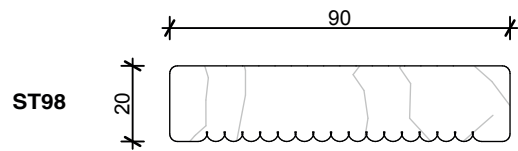

Fascia



20mm thickness

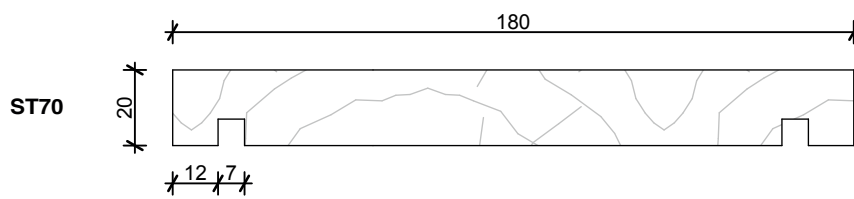

32mm thickness

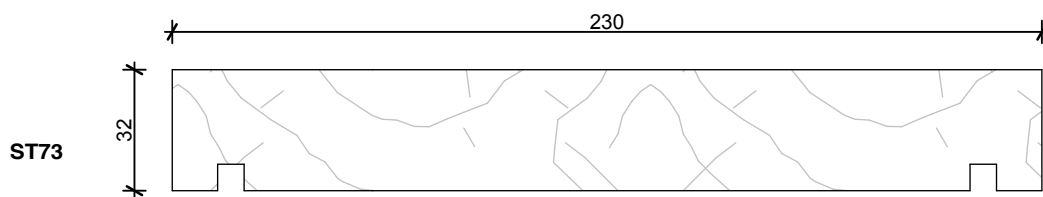
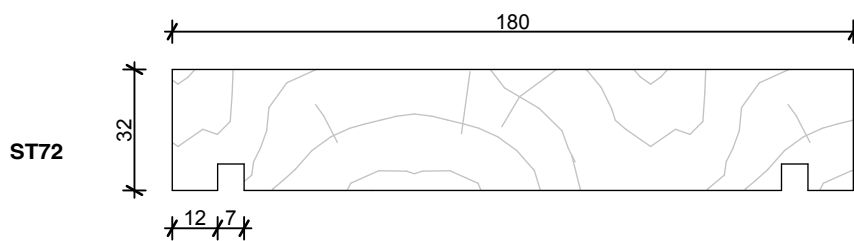
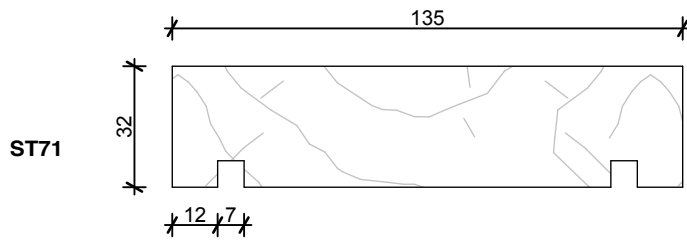

Flooring - Engineered

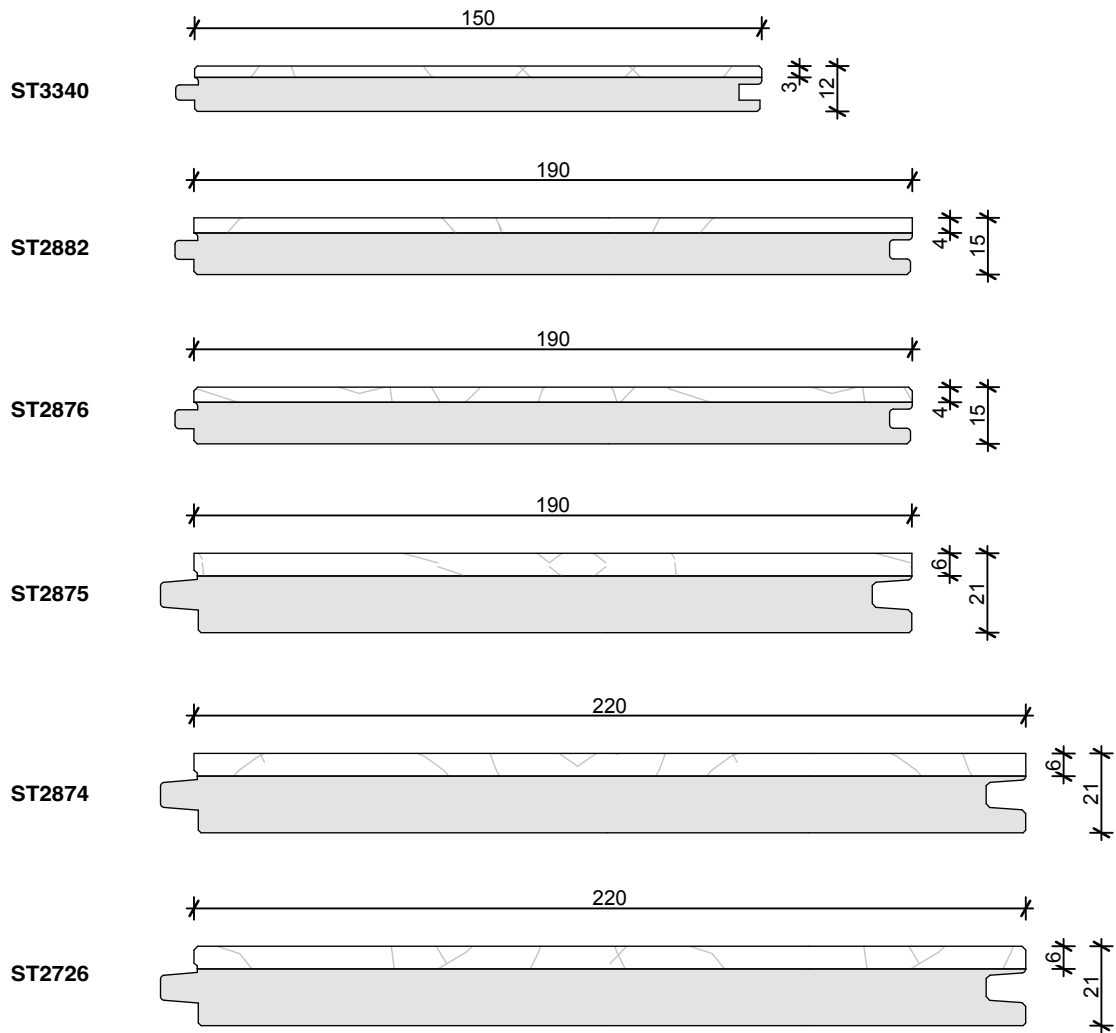

Flooring - Solid Timber



ST3427

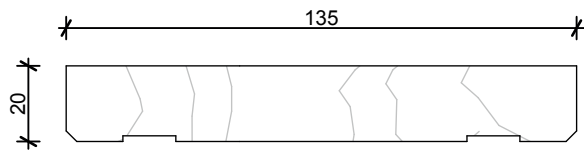

ST3428

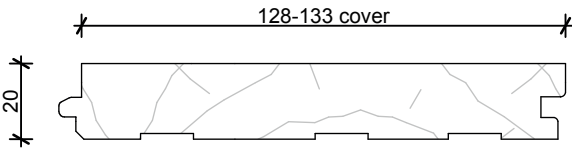

Drop Tounge T&G Flooring 20mm thick

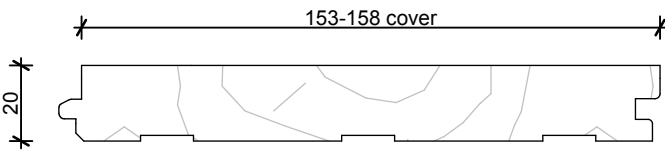

Drop Tounge T&G Flooring 20mm thick

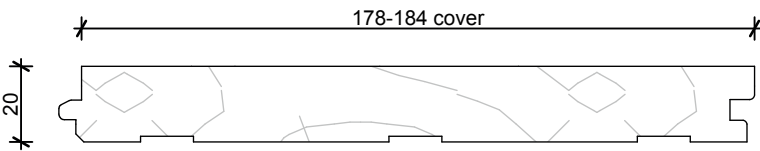

Drop Tounge T&G Flooring 20mm & 21mm thick



Drop Tounge T&G Flooring 20mm & 21mm thick



Drop Tounge T&G Flooring 20mm & 21mm thick

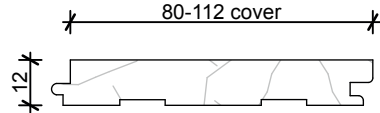

Drop Tounge Overlay Flooring 12mm thick

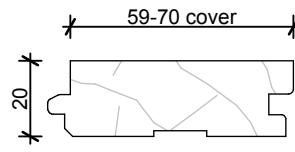

Drop Tounge T&G Flooring 20mm thick

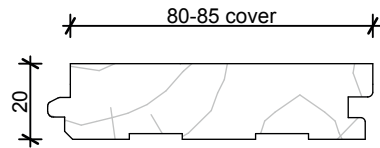

Drop Tounge T&G Flooring 20mm thick

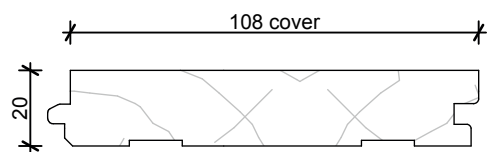

Drop Tounge T&G Flooring 20mm thick

Weatherboards - Horizontal

Bevel Back 20mm thickness

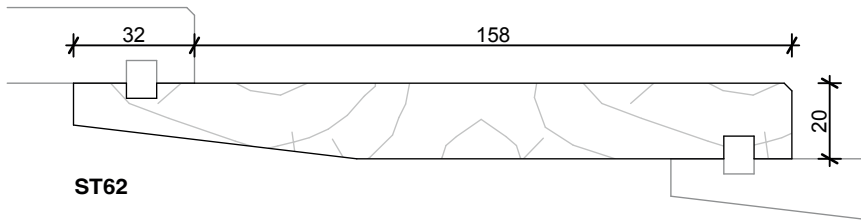
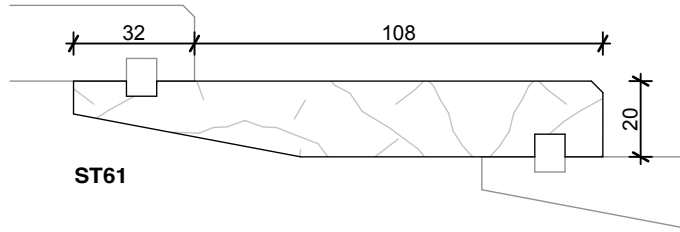

Rebated Bevel Back 20mm thickness

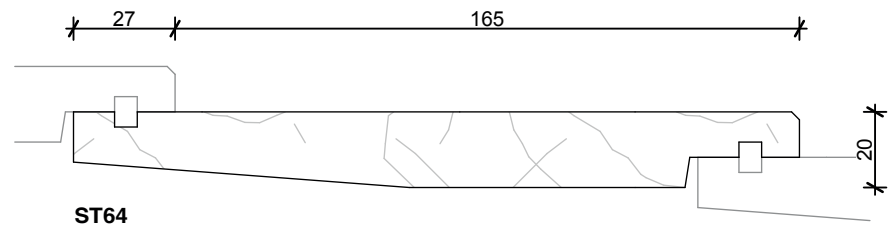
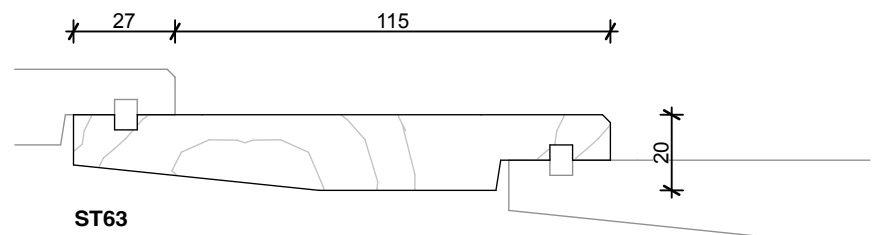

Splaycut Bevel Back 20mm thickness

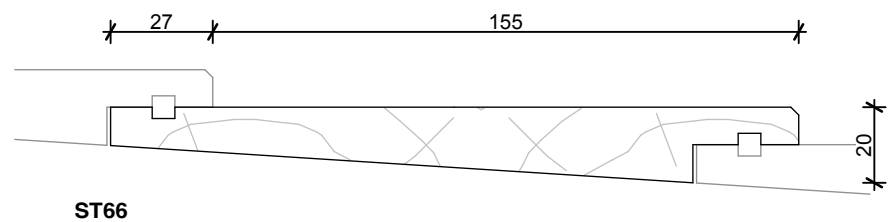
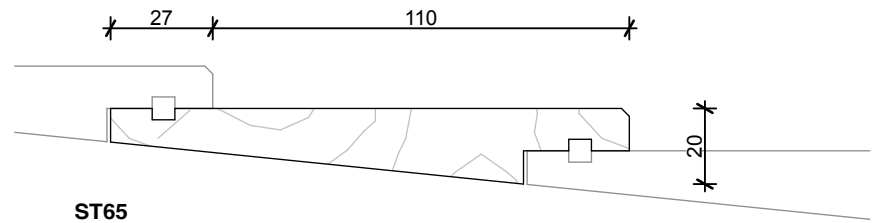

Weatherboards - Horizontal

**Rusticated
20mm thickness**

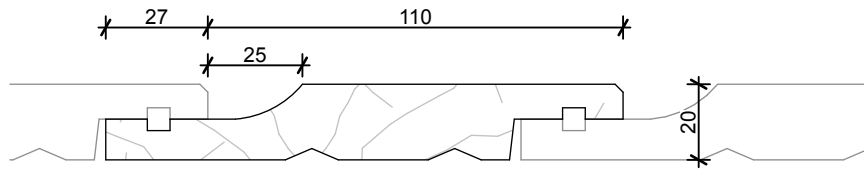

ST67

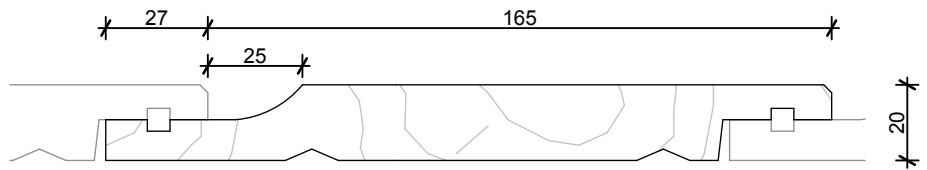

ST68

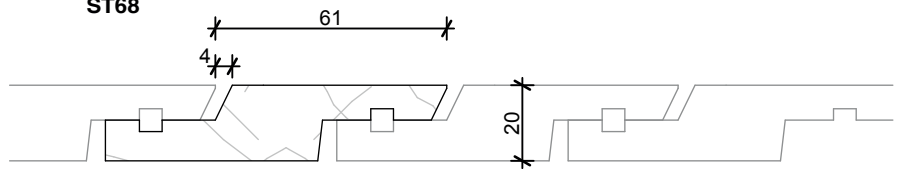

ST837

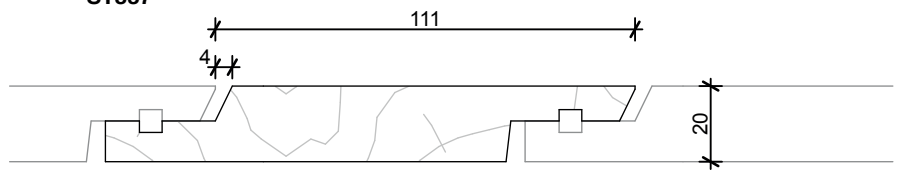

ST835

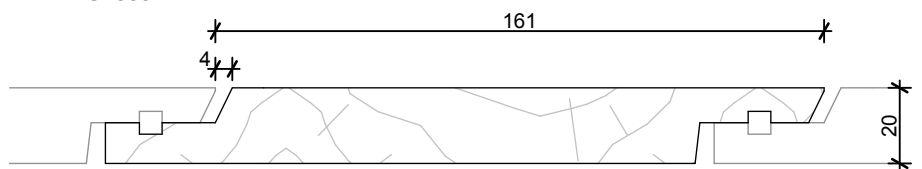

ST836

**Rusticated
32mm thickness**



ST1737

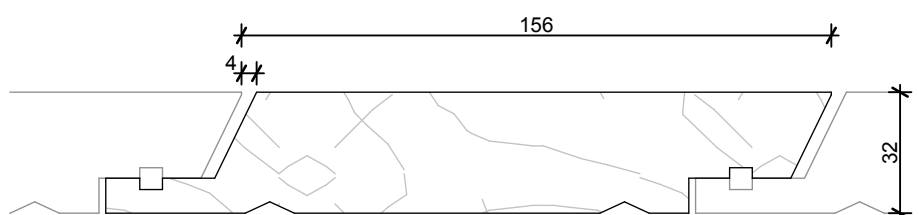

ST1738

Panelling/Sarking

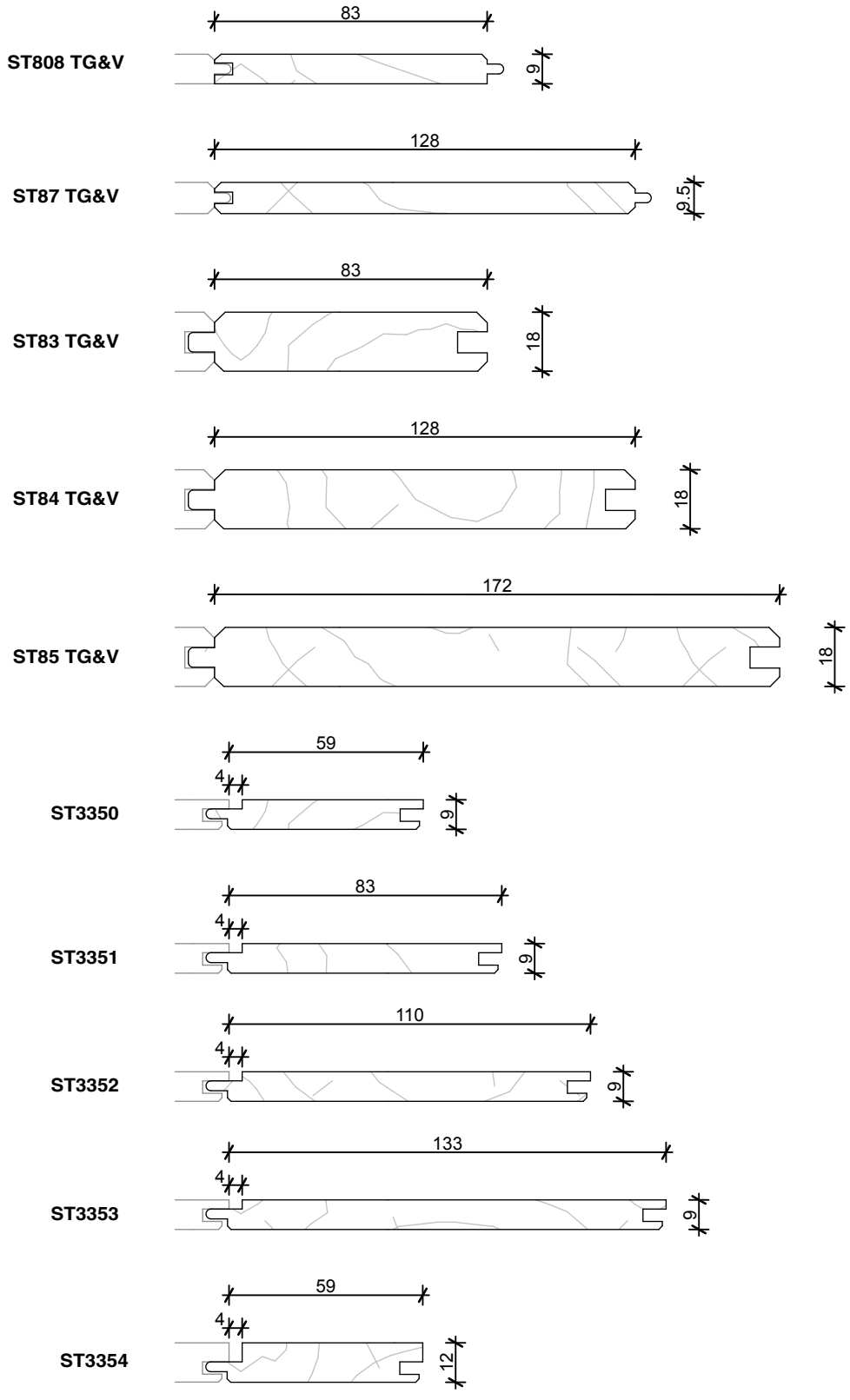

Panelling/Sarking

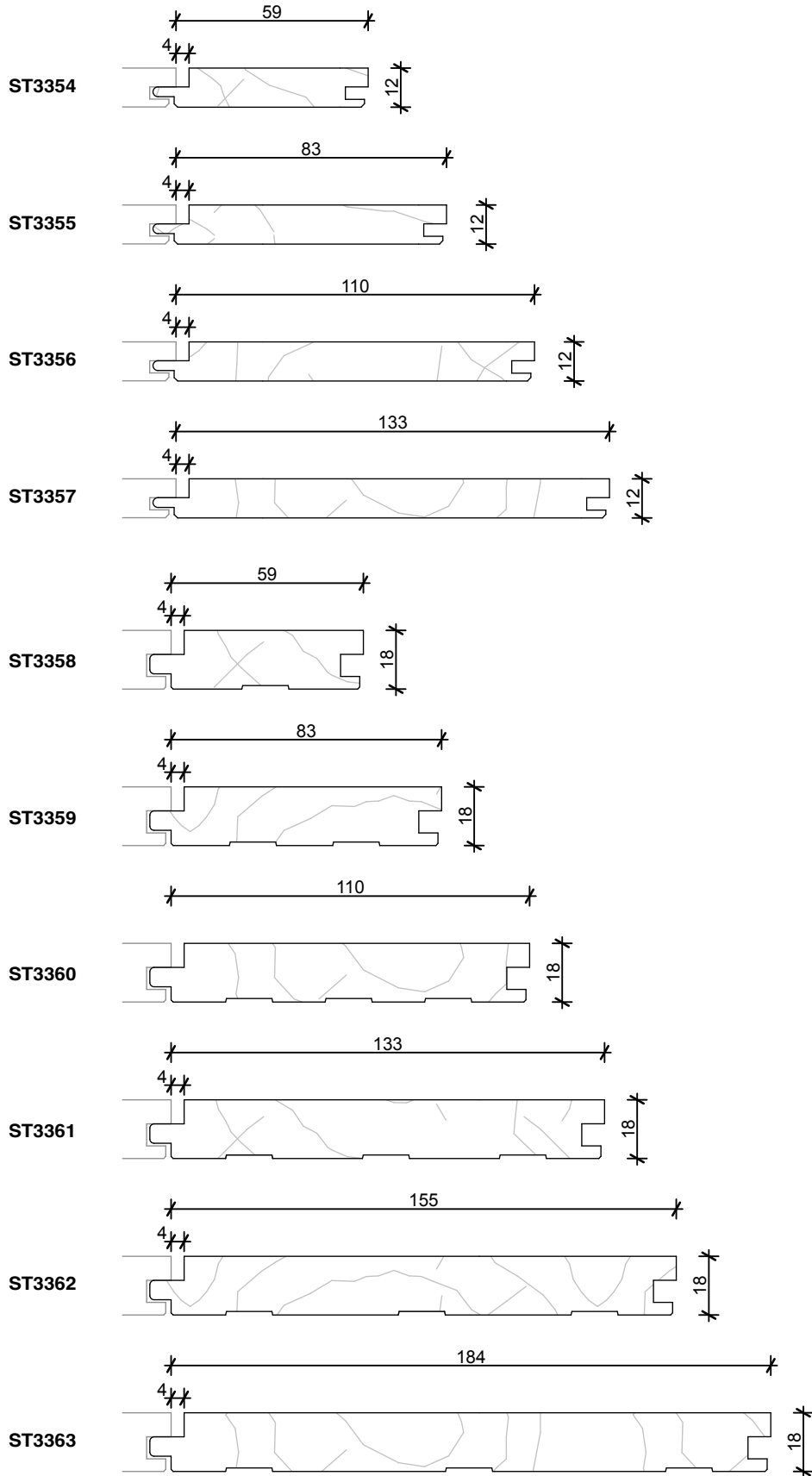

Mouldings



External Corner

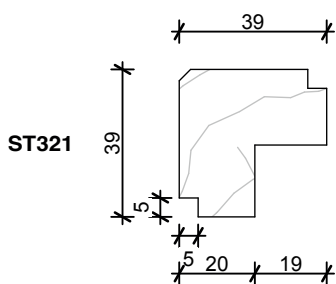
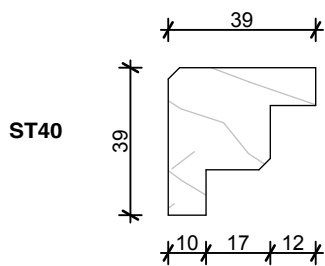
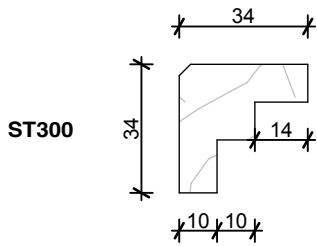
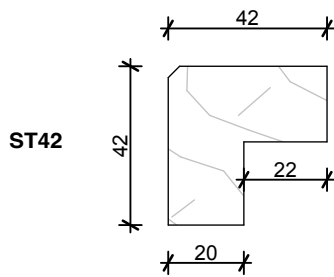
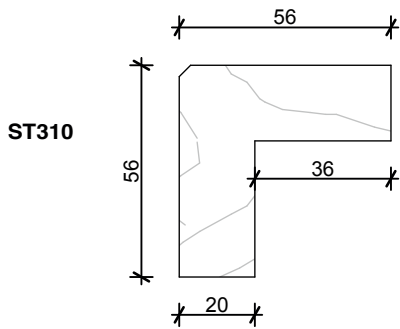

Internal Corners

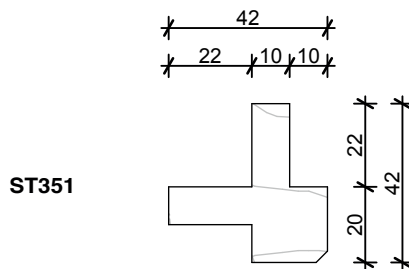
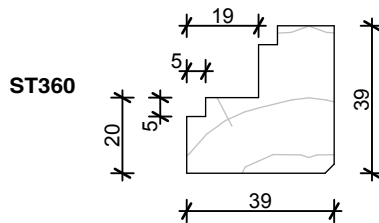
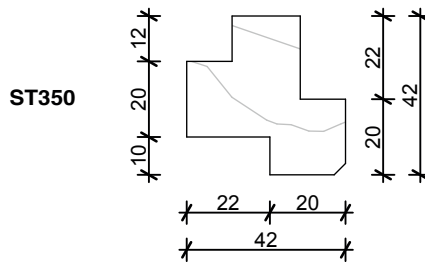
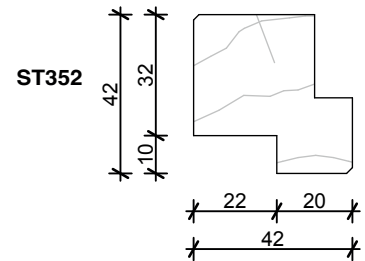
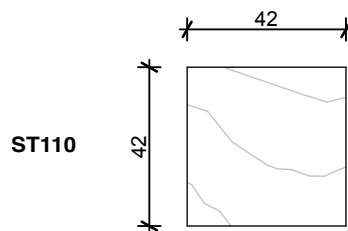
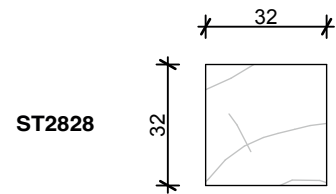
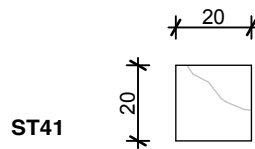

Mouldings

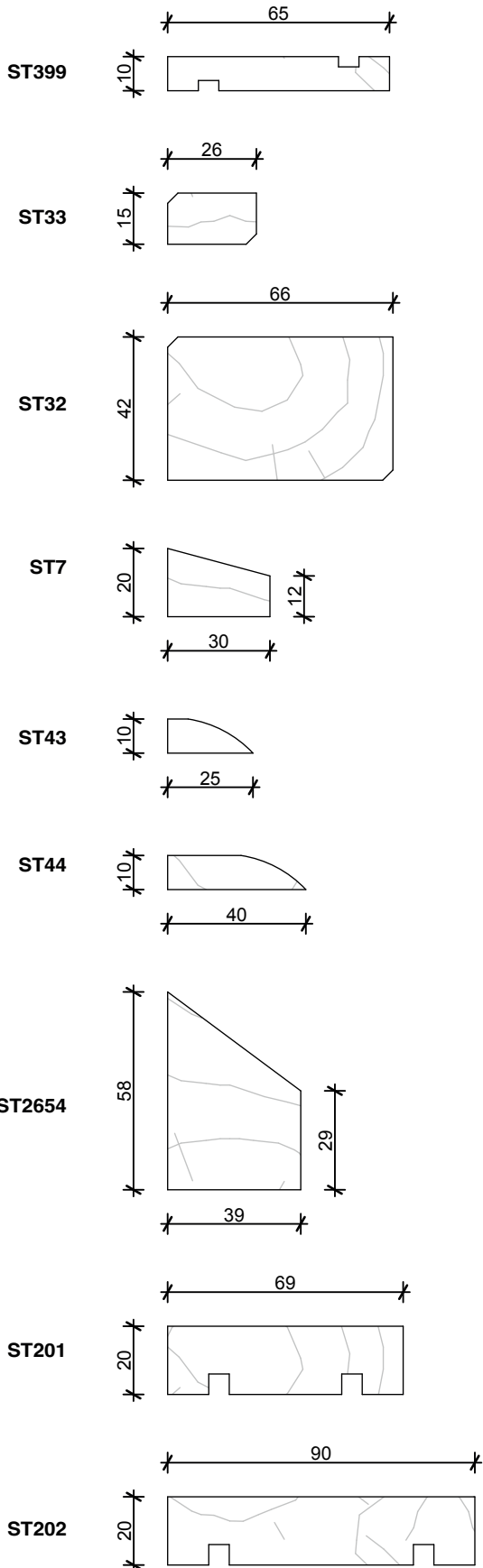

Scribers

