

	SUSTAINABLE BESPOKE TIMBERS - COMMERCIAL & RESIDENTIAL		 FULL SERVICE
	WWW.NZNATURALTIMBER.CO.NZ SALES@NZNATURALTIMBER.CO.NZ - PHONE 0800NZTIMBER	SHOWROOM 51 COMMERCE ST WHANGAREI 0110 NEW ZEALAND	

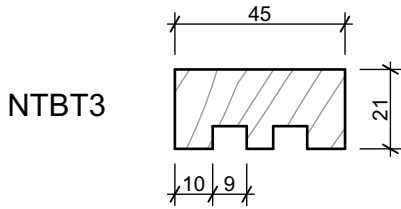

NTBT3 Natural Timber Co. 45 x 21mm Redwood Batten

NTIC1

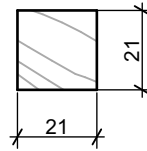

NT Natural Timber Co. Redwood Int Corner Moulding

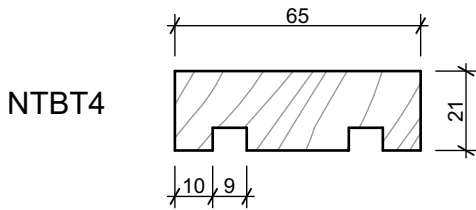

NTBT4 Natural Timber Co. 65 x 21mm Redwood Batten

NTEC1

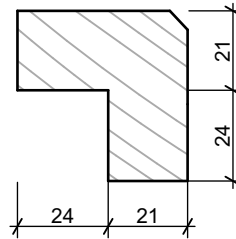

NT Natural Timber Co. Redwood Ext Corner Moulding

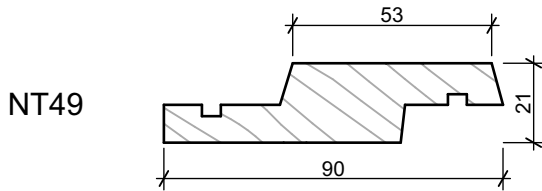

NT49 Natural Timber Co. 90 x 21mm Redwood Vertical Shiplap

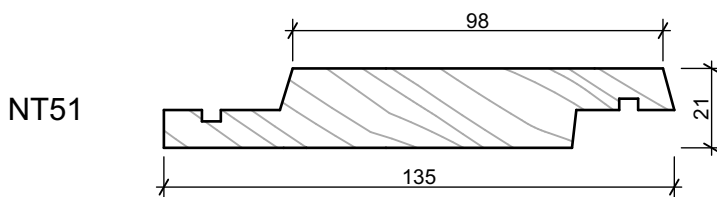

NT51 Natural Timber Co. 135 x 21mm Redwood Vertical Shiplap

NOTES

- All nail fixings pre-drilled min. 1mm diameter smaller than the nail gauge.
- All NZ Natural Timber Co. timber products to be pre-coated and cut ends and edges and all fresh cut surfaces double coated and sealed before fixing.
- All corner flashings to be 75 x 75mm to suit all wind zones. All flashings to have hemmed edges to NZBC E2/AS1.
- Avoid contact in seaspray zones or corrosion zone D between CCA treated timber and metal flashings. Refer NZBC E2/AS1 Table 21

NT-RW.02 Vertical Shiplap Weatherboard System. Cavity Fix		SCALE 1:2 @ A4
DRAWING Board and Batten Profiles		01

	SUSTAINABLE BESPOKE TIMBERS - COMMERCIAL & RESIDENTIAL		 FULL SERVICE
	WWW.NZNATURALTIMBER.CO.NZ SALES@NZNATURALTIMBER.CO.NZ - PHONE 0800NZTIMBER	SHOWROOM 51 COMMERCE ST WHANGAREI 0110 NEW ZEALAND	

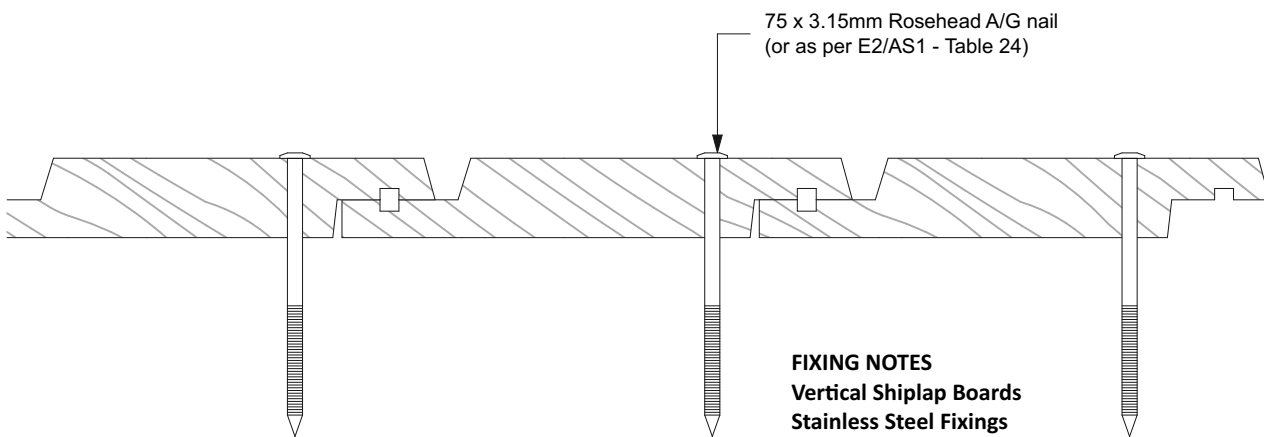
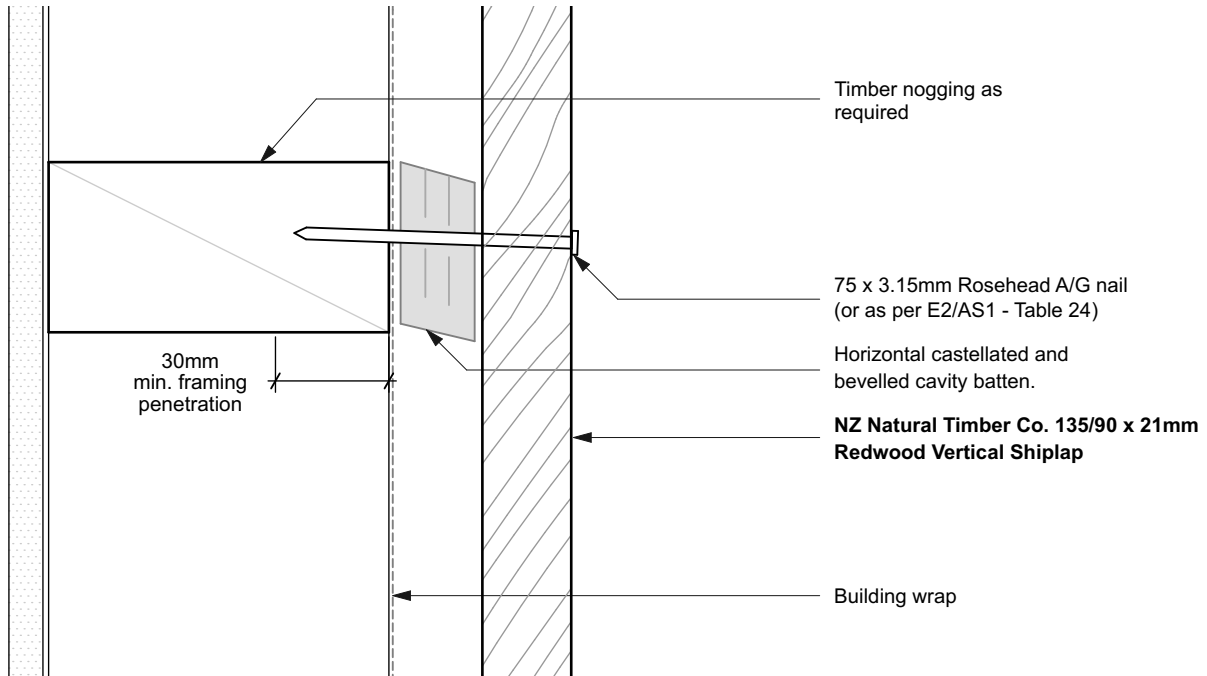

FIXING NOTES

**Vertical Shiplap Boards
Stainless Steel Fixings**

- Rosehead A/G 100 x 4.0mm
- Rosehead A/G 75 x 3.15mm
- Rosehead A/G 60 x 3.15mm
- Rosehead A/G 38 x 3.15mm

Silicone Bronze Fixings

- Rosehead A/G 100 x 4.0mm
- Rosehead A/G 75 x 3.25mm
- Rosehead A/G 60 x 3.25mm
- Rosehead A/G 38 x 3.25mm

NOTES

- All nail fixings pre-drilled min. 1mm diameter smaller than the nail gauge.
- All NZ Natural Timber Co. timber products to be pre-coated and cut ends and edges and all fresh cut surfaces double coated and sealed before fixing.
- All corner flashings to be 75 x 75mm to suit all wind zones. All flashings to have hemmed edges to NZBC E2/AS1.
- Avoid contact in seaspray zones or corrosion zone D between CCA treated timber and metal flashings. Refer NZBC E2/AS1 Table 21

NT-RW.02 Vertical Shiplap Weatherboard System. Cavity Fix		SCALE 1:2 @ A4
DRAWING	Detail Cavity Fix	02

	SUSTAINABLE BESPOKE TIMBERS - COMMERCIAL & RESIDENTIAL		 FULL SERVICE
	WWW.NZNATURALTIMBER.CO.NZ SALES@NZNATURALTIMBER.CO.NZ - PHONE 0800NZTIMBER	SHOWROOM 51 COMMERCE ST WHANGAREI 0110 NEW ZEALAND	

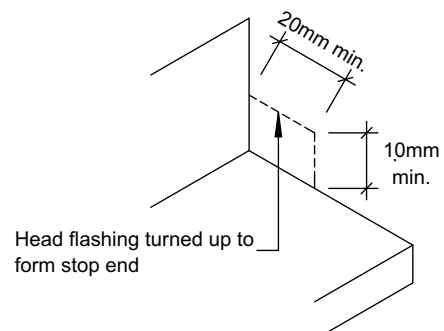
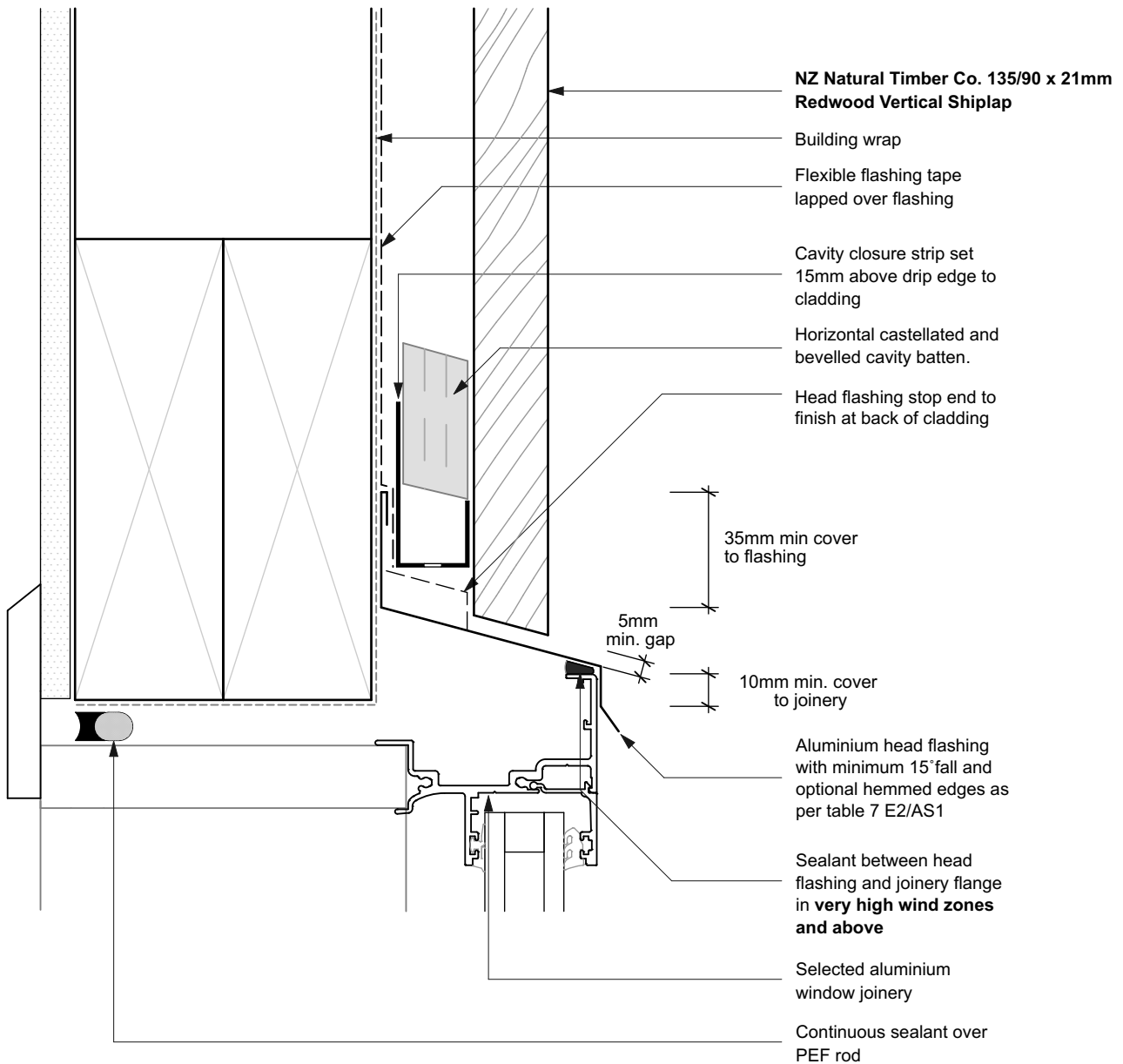

NOTES

- All nail fixings pre-drilled min. 1mm diameter smaller than the nail gauge.
- All NZ Natural Timber Co. timber products to be pre-coated and cut ends and edges and all fresh cut surfaces double coated and sealed before fixing.
- All corner flashings to be 75 x 75mm to suit all wind zones. All flashings to have hemmed edges to NZBC E2/AS1.
- Avoid contact in seaspray zones or corrosion zone D between CCA treated timber and metal flashings. Refer NZBC E2/AS1 Table 21

NT-RW.02 Vertical Shiplap Weatherboard System. Cavity Fix		SCALE 1:2 @ A4
DRAWING	Window Head Detail	03

	SUSTAINABLE BESPOKE TIMBERS - COMMERCIAL & RESIDENTIAL		 FULL SERVICE
	WWW.NZNATURALTIMBER.CO.NZ SALES@NZNATURALTIMBER.CO.NZ - PHONE 0800NZTIMBER	SHOWROOM 51 COMMERCE ST WHANGAREI 0110 NEW ZEALAND	

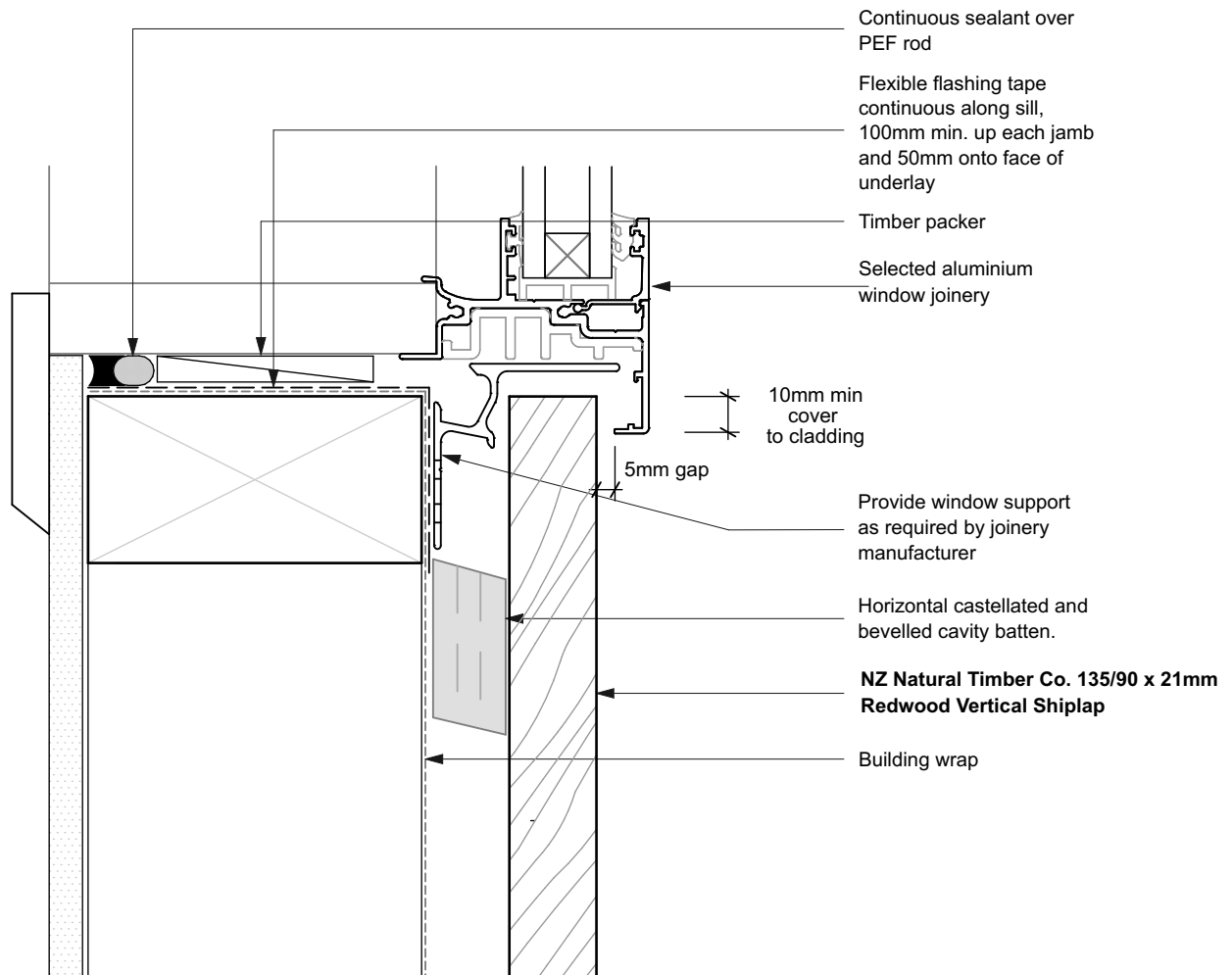

NOTES

- All nail fixings pre-drilled min. 1mm diameter smaller than the nail gauge.
- All NZ Natural Timber Co. timber products to be pre-coated and cut ends and edges and all fresh cut surfaces double coated and sealed before fixing.
- All corner flashings to be 75 x 75mm to suit all wind zones. All flashings to have hemmed edges to NZBC E2/AS1.
- Avoid contact in seaspray zones or corrosion zone D between CCA treated timber and metal flashings. Refer NZBC E2/AS1 Table 21

NT-RW.02 Vertical Shiplap Weatherboard System. Cavity Fix		SCALE 1:2 @ A4
DRAWING	Window Sill Detail	04

	SUSTAINABLE BESPOKE TIMBERS - COMMERCIAL & RESIDENTIAL		 FULL SERVICE
	WWW.NZNATURALTIMBER.CO.NZ SALES@NZNATURALTIMBER.CO.NZ - PHONE 0800NZTIMBER	SHOWROOM 51 COMMERCE ST WHANGAREI 0110 NEW ZEALAND	

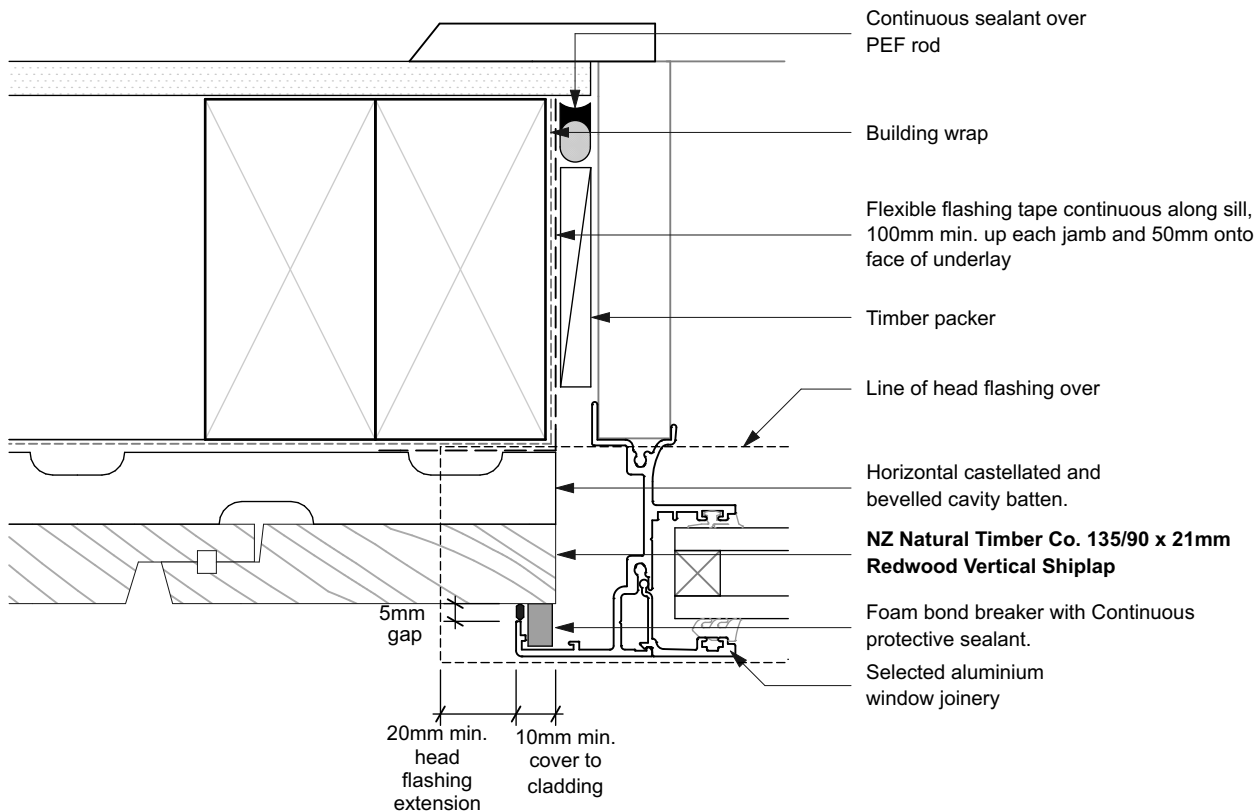

NOTES

- All nail fixings pre-drilled min. 1mm diameter smaller than the nail gauge.
- All NZ Natural Timber Co. timber products to be pre-coated and cut ends and edges and all fresh cut surfaces double coated and sealed before fixing.
- All corner flashings to be 75 x 75mm to suit all wind zones. All flashings to have hemmed edges to NZBC E2/AS1.
- Avoid contact in seaspray zones or corrosion zone D between CCA treated timber and metal flashings. Refer NZBC E2/AS1 Table 21

NT-RW.02 Vertical Shiplap Weatherboard System. Cavity Fix		SCALE 1:2 @ A4
DRAWING Window Jamb Detail		05

	SUSTAINABLE BESPOKE TIMBERS - COMMERCIAL & RESIDENTIAL		
	WWW.NZNATURALTIMBER.CO.NZ SALES@NZNATURALTIMBER.CO.NZ - PHONE 0800NZTIMBER	SHOWROOM 51 COMMERCE ST WHANGAREI 0110 NEW ZEALAND	

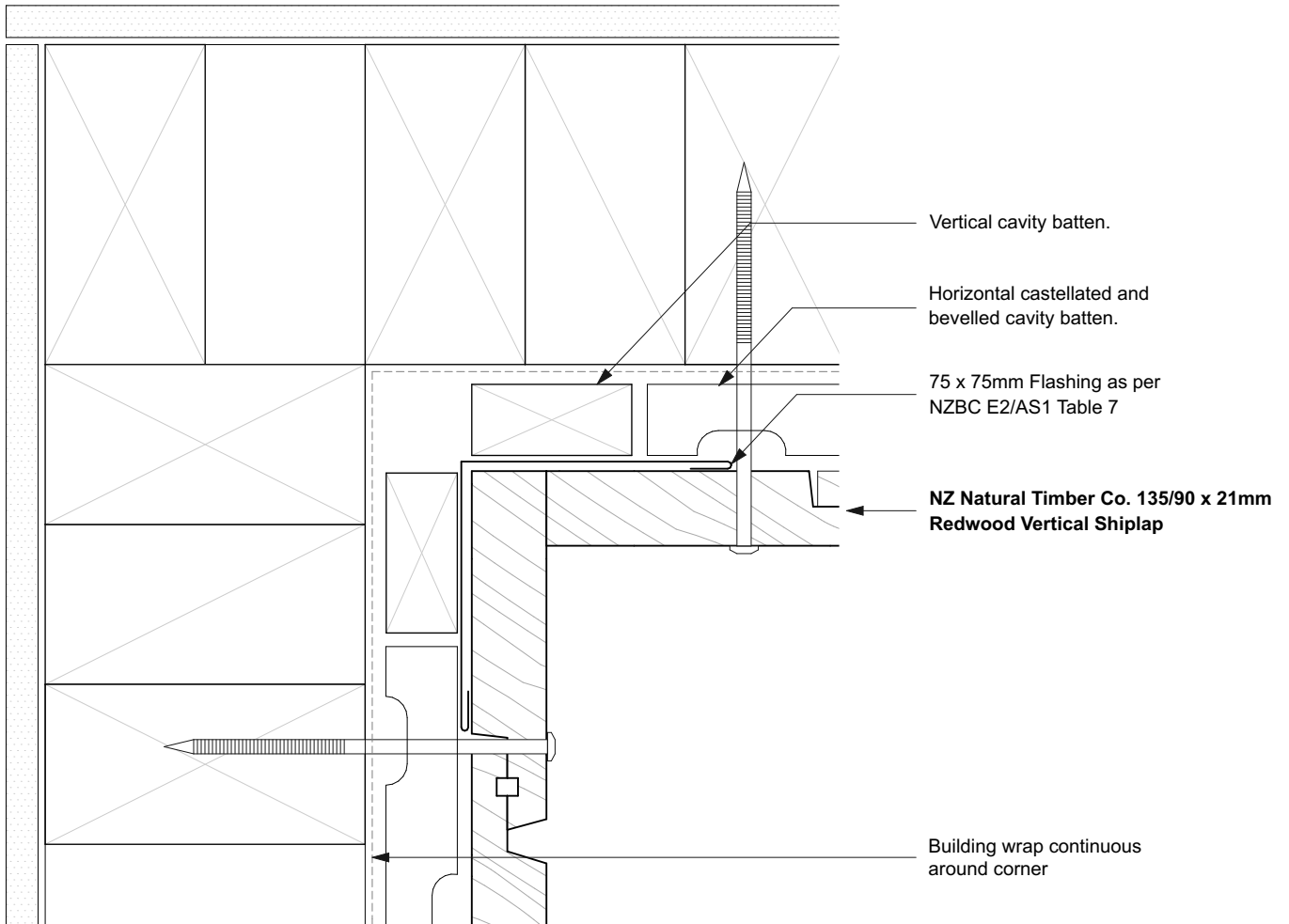

NOTES

- All nail fixings pre-drilled min. 1mm diameter smaller than the nail gauge.
- All NZ Natural Timber Co. timber products to be pre-coated and cut ends and edges and all fresh cut surfaces double coated and sealed before fixing.
- All corner flashings to be 75 x 75mm to suit all wind zones. All flashings to have hemmed edges to NZBC E2/AS1.
- Avoid contact in seaspray zones or corrosion zone D between CCA treated timber and metal flashings. Refer NZBC E2/AS1 Table 21

NT-RW.02 Vertical Shiplap Weatherboard System. Cavity Fix		SCALE 1:2 @ A4
DRAWING	Internal Corner Edge to Edge	06

	SUSTAINABLE BESPOKE TIMBERS - COMMERCIAL & RESIDENTIAL		
	WWW.NZNATURALTIMBER.CO.NZ SALES@NZNATURALTIMBER.CO.NZ - PHONE 0800NZTIMBER	SHOWROOM 51 COMMERCE ST WHANGAREI 0110 NEW ZEALAND	

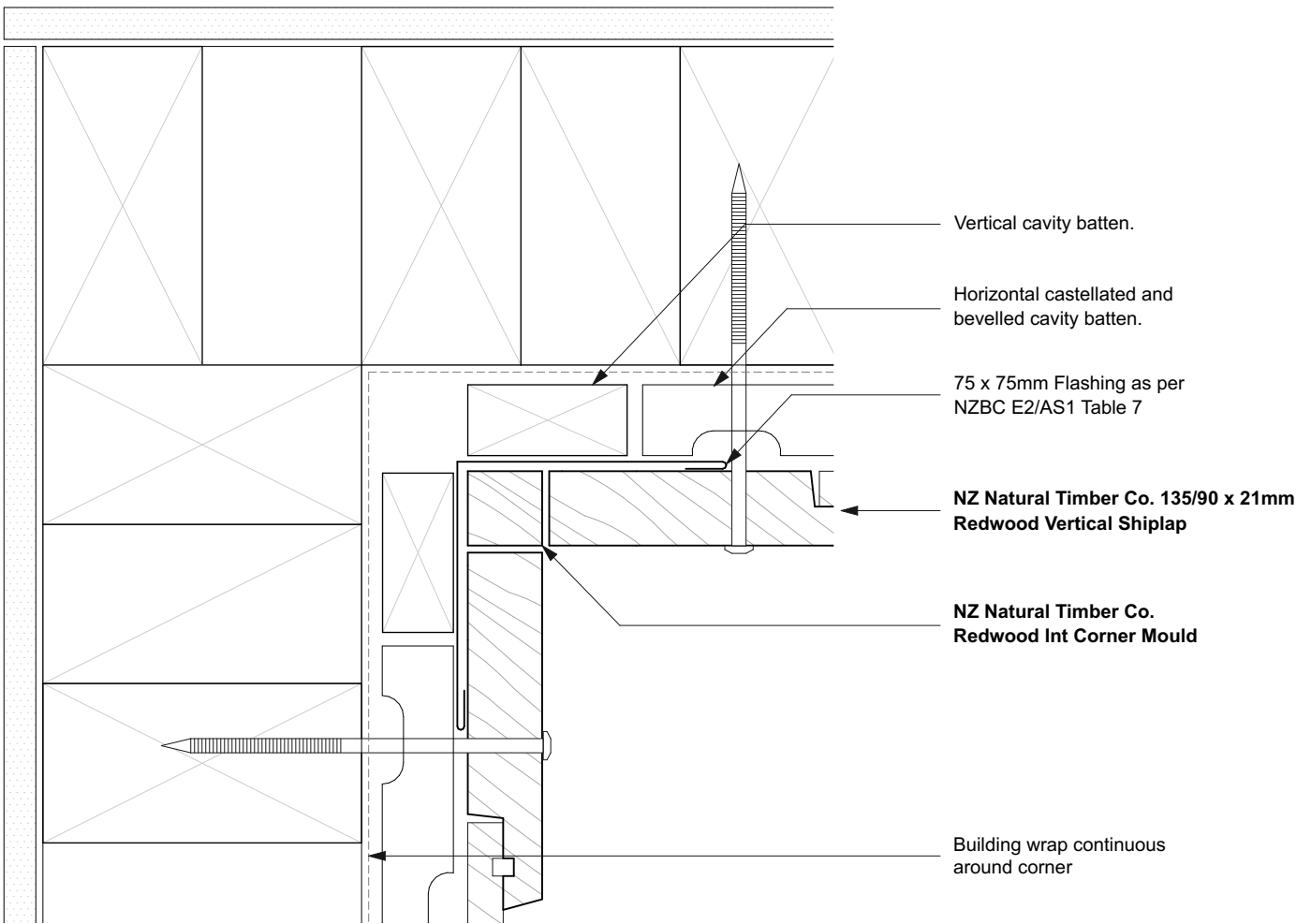

NOTES

- All nail fixings pre-drilled min. 1mm diameter smaller than the nail gauge.
- All NZ Natural Timber Co. timber products to be pre-coated and cut ends and edges and all fresh cut surfaces double coated and sealed before fixing.
- All corner flashings to be 75 x 75mm to suit all wind zones. All flashings to have hemmed edges to NZBC E2/AS1.
- Avoid contact in seaspray zones or corrosion zone D between CCA treated timber and metal flashings. Refer NZBC E2/AS1 Table 21

NT-RW.02 Vertical Shiplap Weatherboard System. Cavity Fix		SCALE 1:2 @ A4
DRAWING	Internal Corner Detail	07

	SUSTAINABLE BESPOKE TIMBERS - COMMERCIAL & RESIDENTIAL		
	WWW.NZNATURALTIMBER.CO.NZ SALES@NZNATURALTIMBER.CO.NZ - PHONE 0800NZTIMBER	SHOWROOM 51 COMMERCE ST WHANGAREI 0110 NEW ZEALAND	

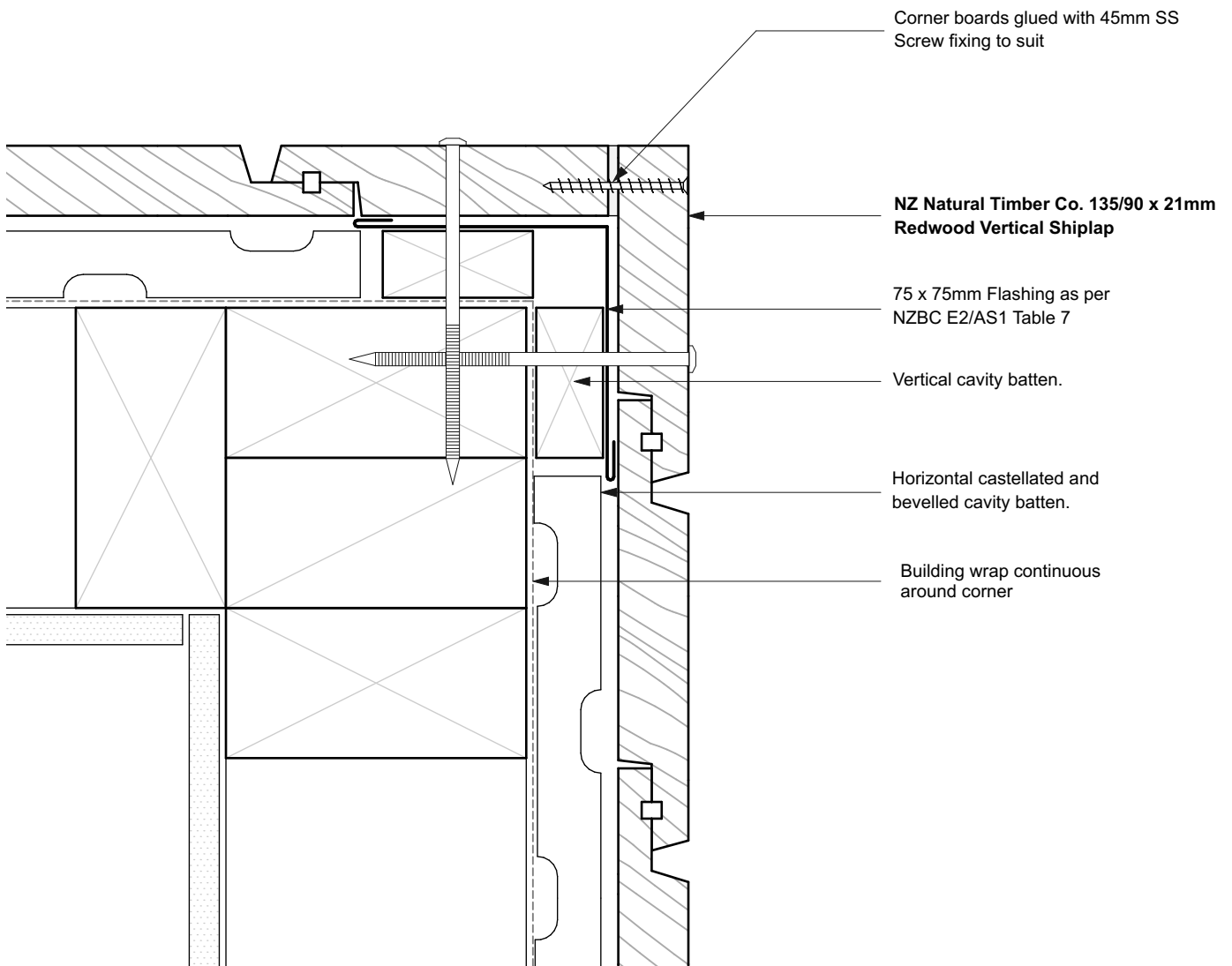

NOTES

- All nail fixings pre-drilled min. 1mm diameter smaller than the nail gauge.
- All NZ Natural Timber Co. timber products to be pre-coated and cut ends and edges and all fresh cut surfaces double coated and sealed before fixing.
- All corner flashings to be 75 x 75mm to suit all wind zones. All flashings to have hemmed edges to NZBC E2/AS1.
- Avoid contact in seaspray zones or corrosion zone D between CCA treated timber and metal flashings. Refer NZBC E2/AS1 Table 21

NT-RW.02 Vertical Shiplap Weatherboard System. Cavity Fix		SCALE 1:2 @ A4
DRAWING External Corner Detail		08

	SUSTAINABLE BESPOKE TIMBERS - COMMERCIAL & RESIDENTIAL		
	WWW.NZNATURALTIMBER.CO.NZ SALES@NZNATURALTIMBER.CO.NZ - PHONE 0800NZTIMBER	SHOWROOM 51 COMMERCE ST WHANGAREI 0110 NEW ZEALAND	

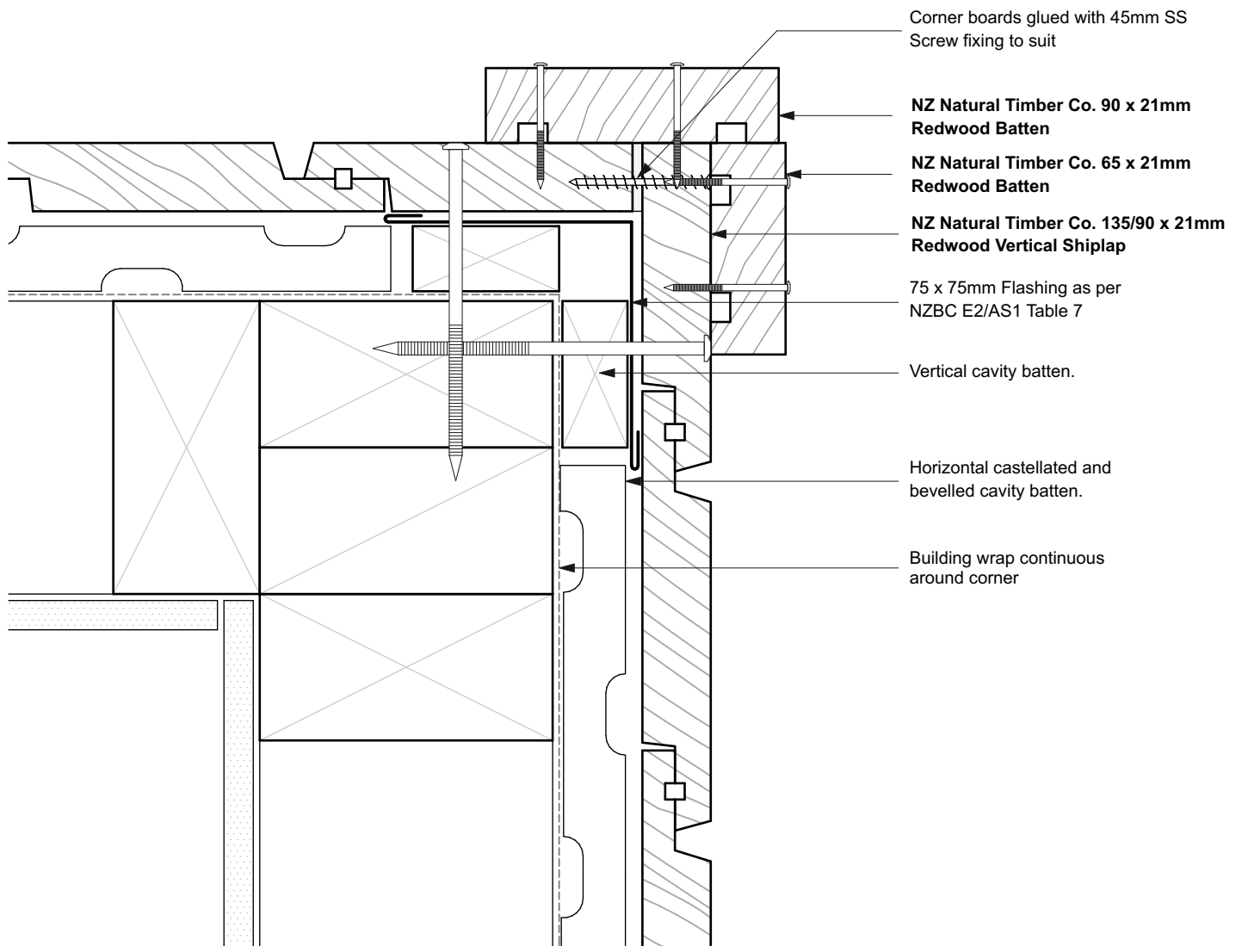

NOTES

- All nail fixings pre-drilled min. 1mm diameter smaller than the nail gauge.
- All NZ Natural Timber Co. timber products to be pre-coated and cut ends and edges and all fresh cut surfaces double coated and sealed before fixing.
- All corner flashings to be 75 x 75mm to suit all wind zones. All flashings to have hemmed edges to NZBC E2/AS1.
- Avoid contact in seaspray zones or corrosion zone D between CCA treated timber and metal flashings. Refer NZBC E2/AS1 Table 21

NT-RW.02 Vertical Shiplap Weatherboard System. Cavity Fix	SCALE 1:2 @ A4
DRAWING External Corner Boxed	09

	SUSTAINABLE BESPOKE TIMBERS - COMMERCIAL & RESIDENTIAL		
	WWW.NZNATURALTIMBER.CO.NZ SALES@NZNATURALTIMBER.CO.NZ - PHONE 0800NZTIMBER	SHOWROOM 51 COMMERCE ST WHANGAREI 0110 NEW ZEALAND	

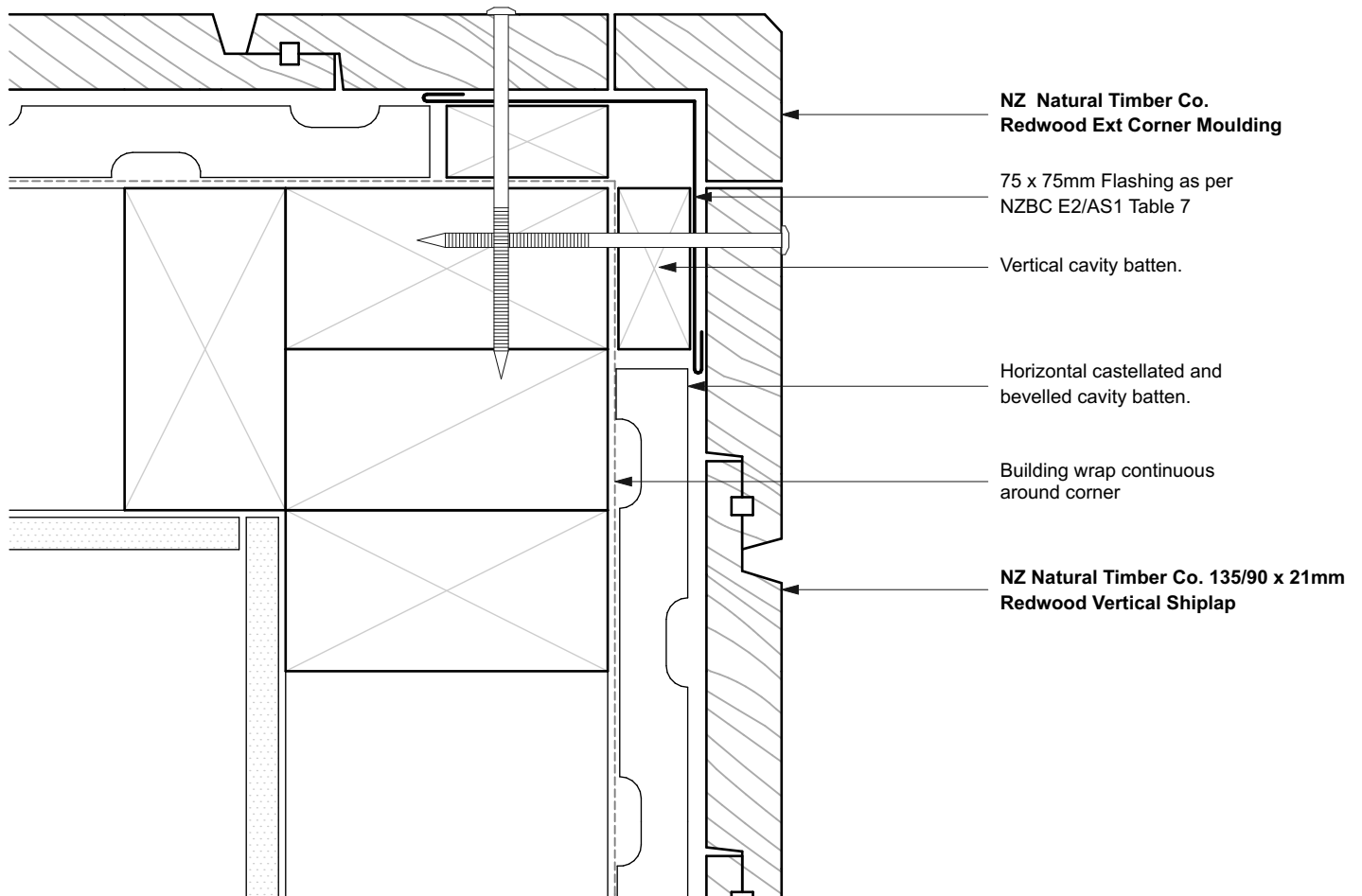

NOTES

- All nail fixings pre-drilled min. 1mm diameter smaller than the nail gauge.
- All NZ Natural Timber Co. timber products to be pre-coated and cut ends and edges and all fresh cut surfaces double coated and sealed before fixing.
- All corner flashings to be 75 x 75mm to suit all wind zones. All flashings to have hemmed edges to NZBC E2/AS1.
- Avoid contact in seaspray zones or corrosion zone D between CCA treated timber and metal flashings. Refer NZBC E2/AS1 Table 21

NT-RW.02 Vertical Shiplap Weatherboard System. Cavity Fix		SCALE 1:2 @ A4
DRAWING	External Corner Moulding Detail	10

	SUSTAINABLE BESPOKE TIMBERS - COMMERCIAL & RESIDENTIAL		
	WWW.NZNATURALTIMBER.CO.NZ SALES@NZNATURALTIMBER.CO.NZ - PHONE 0800NZTIMBER	SHOWROOM 51 COMMERCE ST WHANGAREI 0110 NEW ZEALAND	

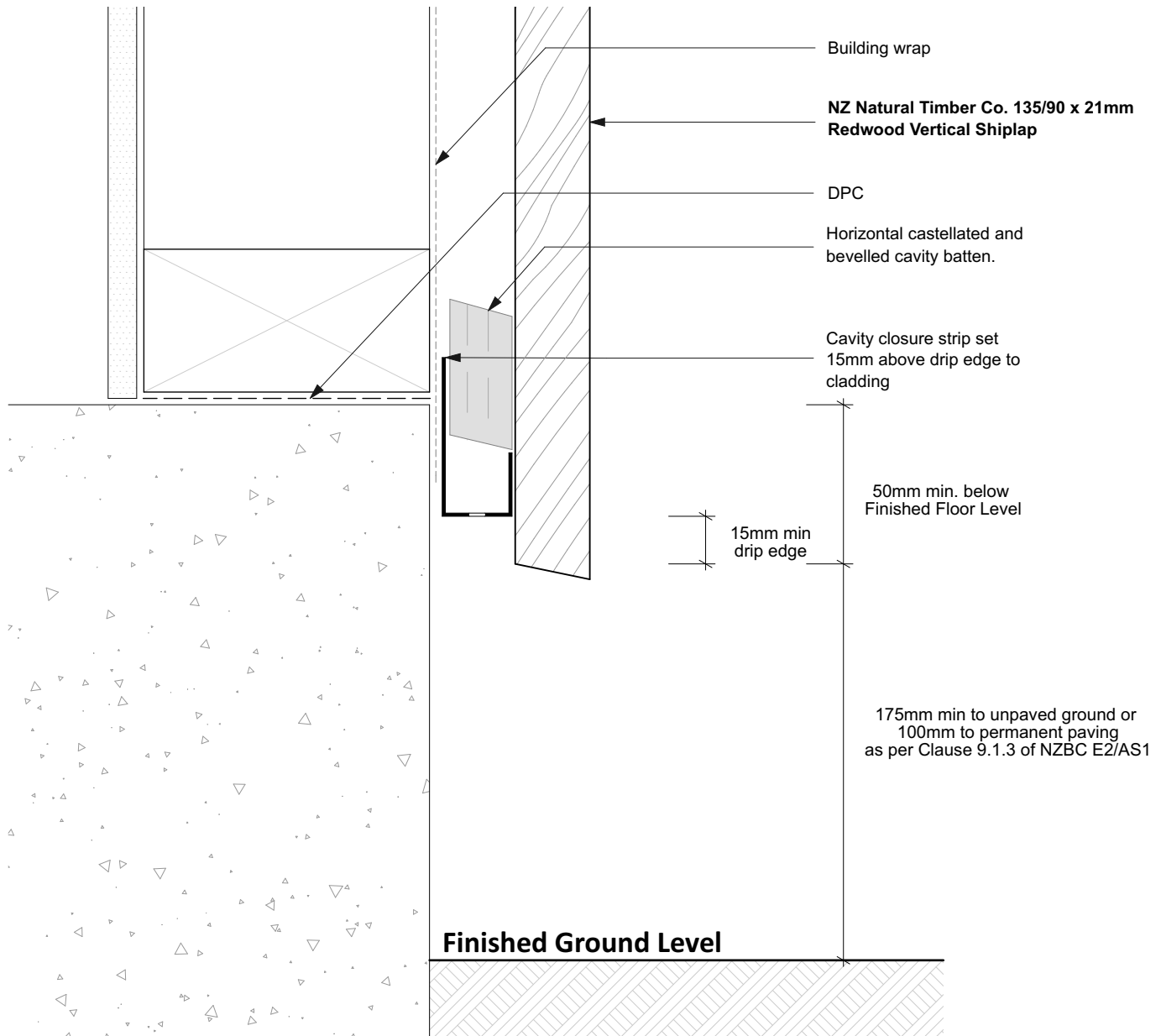

NOTES

- All nail fixings pre-drilled min. 1mm diameter smaller than the nail gauge.
- All NZ Natural Timber Co. timber products to be pre-coated and cut ends and edges and all fresh cut surfaces double coated and sealed before fixing.
- All corner flashings to be 75 x 75mm to suit all wind zones. All flashings to have hemmed edges to NZBC E2/AS1.
- Avoid contact in seaspray zones or corrosion zone D between CCA treated timber and metal flashings. Refer NZBC E2/AS1 Table 21

NT-RW.02 Vertical Shiplap Weatherboard System. Cavity Fix		SCALE 1:2 @ A4
DRAWING	Base of Wall - Concrete	11

	SUSTAINABLE BESPOKE TIMBERS - COMMERCIAL & RESIDENTIAL		 FULL SERVICE
	WWW.NZNATURALTIMBER.CO.NZ SALES@NZNATURALTIMBER.CO.NZ - PHONE 0800NZTIMBER	SHOWROOM 51 COMMERCE ST WHANGAREI 0110 NEW ZEALAND	

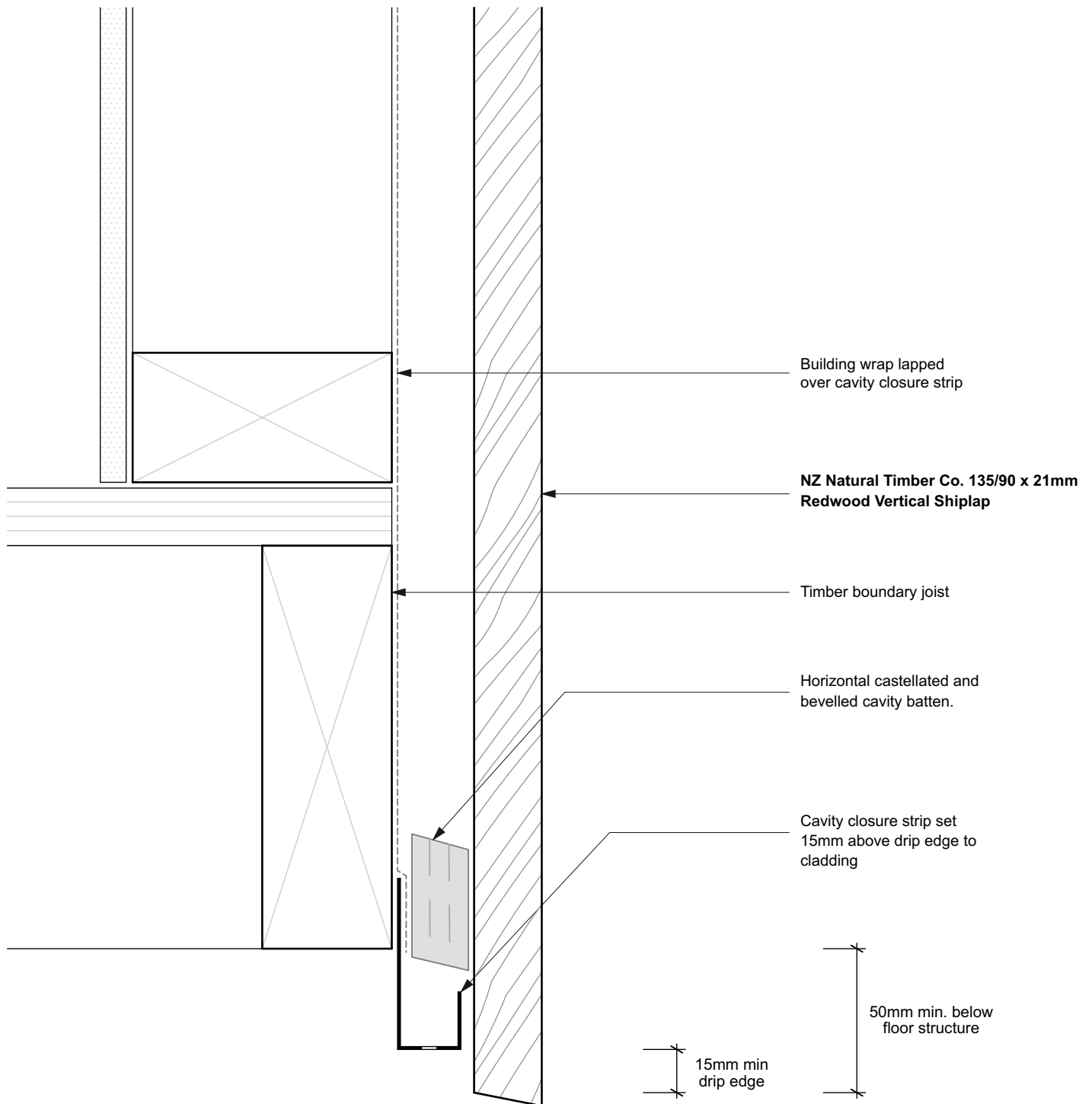

NOTES

- All nail fixings pre-drilled min. 1mm diameter smaller than the nail gauge.
- All NZ Natural Timber Co. timber products to be pre-coated and cut ends and edges and all fresh cut surfaces double coated and sealed before fixing.
- All corner flashings to be 75 x 75mm to suit all wind zones. All flashings to have hemmed edges to NZBC E2/AS1.
- Avoid contact in seaspray zones or corrosion zone D between CCA treated timber and metal flashings. Refer NZBC E2/AS1 Table 21

NT-RW.02 Vertical Shiplap Weatherboard System. Cavity Fix		SCALE 1:2 @ A4
DRAWING	Base of Wall - Timber	12

	SUSTAINABLE BESPOKE TIMBERS - COMMERCIAL & RESIDENTIAL		⌄
	WWW.NZNATURALTIMBER.CO.NZ SALES@NZNATURALTIMBER.CO.NZ - PHONE 0800NZTIMBER	SHOWROOM 51 COMMERCE ST WHANGAREI 0110 NEW ZEALAND	FULL SERVICE

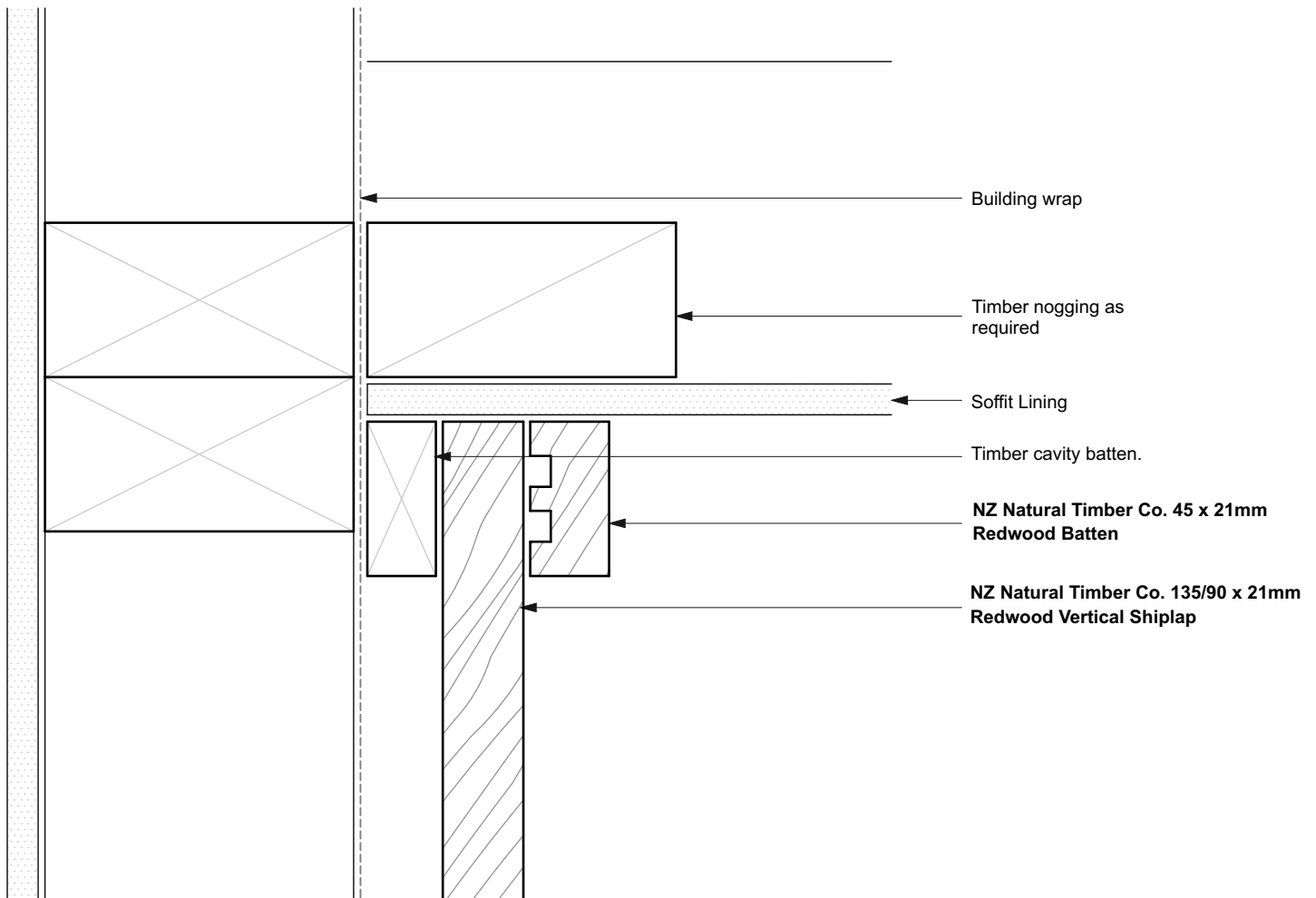

NOTES

- All nail fixings pre-drilled min. 1mm diameter smaller than the nail gauge.
- All NZ Natural Timber Co. timber products to be pre-coated and cut ends and edges and all fresh cut surfaces double coated and sealed before fixing.
- All corner flashings to be 75 x 75mm to suit all wind zones. All flashings to have hemmed edges to NZBC E2/AS1.
- Avoid contact in seaspray zones or corrosion zone D between CCA treated timber and metal flashings. Refer NZBC E2/AS1 Table 21

NT-RW.02 Vertical Shiplap Weatherboard System. Cavity Fix		SCALE 1:2 @ A4
DRAWING	Soffit Detail Overhang	13

	SUSTAINABLE BESPOKE TIMBERS - COMMERCIAL & RESIDENTIAL		 FULL SERVICE
	WWW.NZNATURALTIMBER.CO.NZ SALES@NZNATURALTIMBER.CO.NZ - PHONE 0800NZTIMBER	SHOWROOM 51 COMMERCE ST WHANGAREI 0110 NEW ZEALAND	

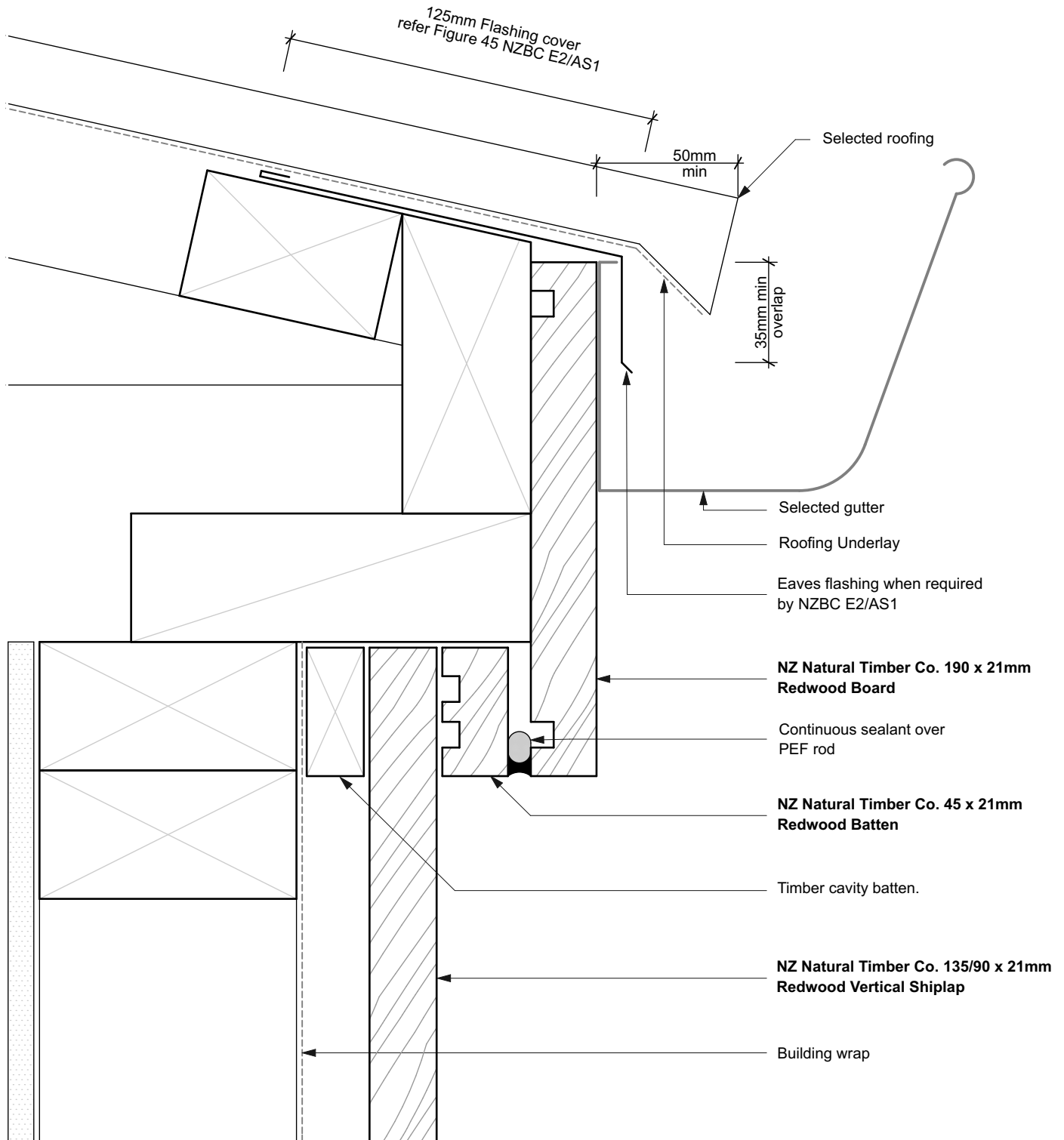

NOTES

- All nail fixings pre-drilled min. 1mm diameter smaller than the nail gauge.
- All NZ Natural Timber Co. timber products to be pre-coated and cut ends and edges and all fresh cut surfaces double coated and sealed before fixing.
- All corner flashings to be 75 x 75mm to suit all wind zones. All flashings to have hemmed edges to NZBC E2/AS1.
- Avoid contact in seaspray zones or corrosion zone D between CCA treated timber and metal flashings. Refer NZBC E2/AS1 Table 21

NT-RW.02 Vertical Shiplap Weatherboard System. Cavity Fix		SCALE 1:2 @ A4
DRAWING	Eaves Detail	14

	SUSTAINABLE BESPOKE TIMBERS - COMMERCIAL & RESIDENTIAL		 FULL SERVICE
	WWW.NZNATURALTIMBER.CO.NZ SALES@NZNATURALTIMBER.CO.NZ - PHONE 0800NZTIMBER	SHOWROOM 51 COMMERCE ST WHANGAREI 0110 NEW ZEALAND	

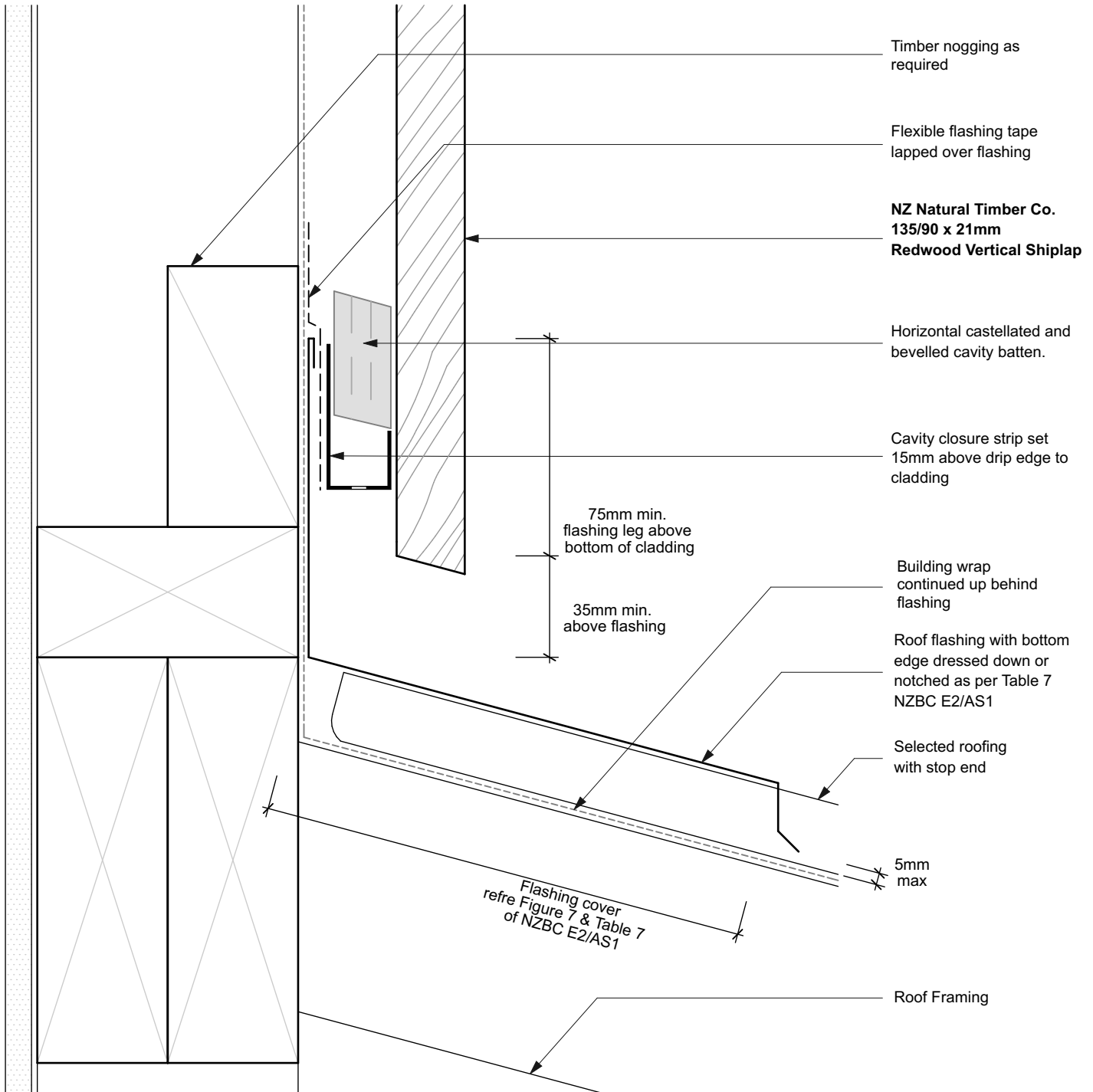

NOTES

- All nail fixings pre-drilled min. 1mm diameter smaller than the nail gauge.
- All NZ Natural Timber Co. timber products to be pre-coated and cut ends and edges and all fresh cut surfaces double coated and sealed before fixing.
- All corner flashings to be 75 x 75mm to suit all wind zones. All flashings to have hemmed edges to NZBC E2/AS1.
- Avoid contact in seaspray zones or corrosion zone D between CCA treated timber and metal flashings. Refer NZBC E2/AS1 Table 21

NT-RW.02 Vertical Shiplap Weatherboard System. Cavity Fix		SCALE 1:2 @ A4
DRAWING Roof/Wall Junction Detail		15

	SUSTAINABLE BESPOKE TIMBERS - COMMERCIAL & RESIDENTIAL		
	WWW.NZNATURALTIMBER.CO.NZ SALES@NZNATURALTIMBER.CO.NZ - PHONE 0800NZTIMBER	SHOWROOM 51 COMMERCE ST WHANGAREI 0110 NEW ZEALAND	

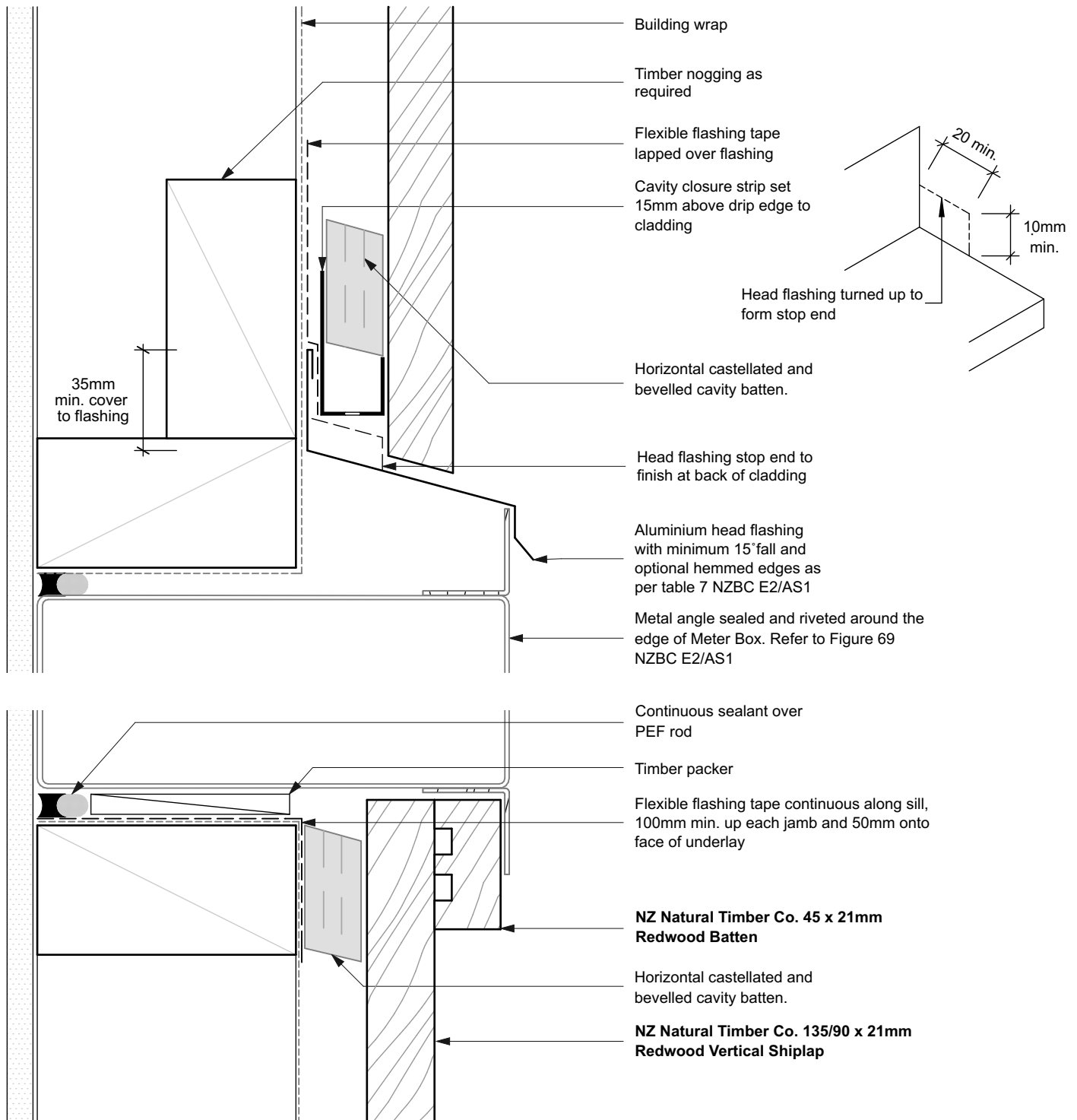

NOTES

- All nail fixings pre-drilled min. 1mm diameter smaller than the nail gauge.
- All NZ Natural Timber Co. timber products to be pre-coated and cut ends and edges and all fresh cut surfaces double coated and sealed before fixing.
- All corner flashings to be 75 x 75mm to suit all wind zones. All flashings to have hemmed edges to NZBC E2/AS1.
- Avoid contact in seaspray zones or corrosion zone D between CCA treated timber and metal flashings. Refer NZBC E2/AS1 Table 21

NT-RW.02 Vertical Shiplap Weatherboard System. Cavity Fix		SCALE 1:2 @ A4
DRAWING	Meter Box Detail	16