

	SUSTAINABLE BESPOKE TIMBERS - COMMERCIAL & RESIDENTIAL		
	WWW.NZNATURALTIMBER.CO.NZ SALES@NZNATURALTIMBER.CO.NZ - PHONE 0800NZTIMBER	SHOWROOM 51 COMMERCE ST WHANGAREI 0110 NEW ZEALAND	

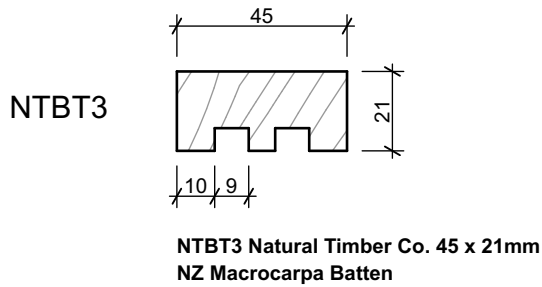

NTIC1

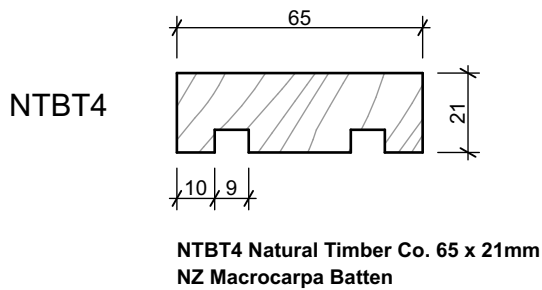
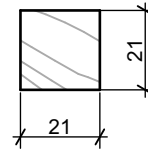

NTEC1

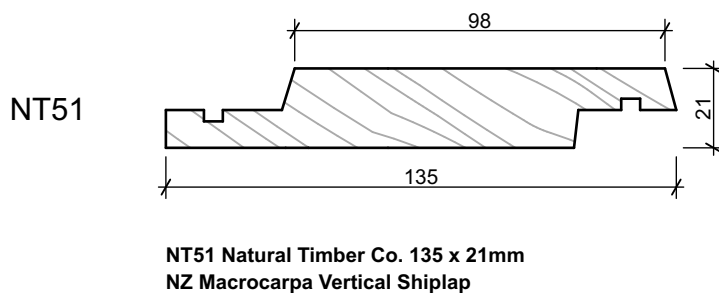
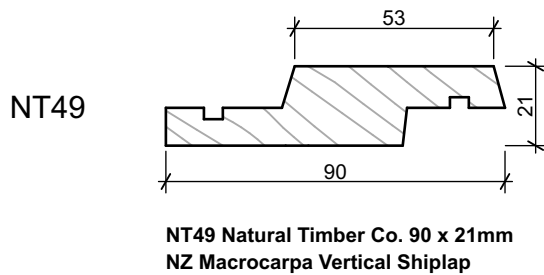
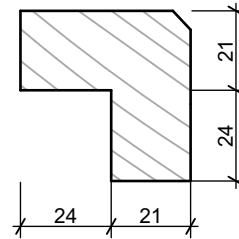

NOTES

- All nail fixings pre-drilled min. 1mm diameter smaller than the nail gauge.
- All NZ Natural Timber Co. timber products to be pre-coated and cut ends and edges and all fresh cut surfaces double coated and sealed before fixing.
- All corner flashings to be 75 x 75mm to suit all wind zones. All flashings to have hemmed edges to NZBC E2/AS1.
- Avoid contact in seaspray zones or corrosion zone D between CCA treated timber and metal flashings. Refer NZBC E2/AS1 Table 21

NT-MC.02 Vertical Shiplap Weatherboard System. Cavity Fix		SCALE 1:2 @ A4
DRAWING Board and Batten Profiles		01

	SUSTAINABLE BESPOKE TIMBERS - COMMERCIAL & RESIDENTIAL		 FULL SERVICE
	WWW.NZNATURALTIMBER.CO.NZ SALES@NZNATURALTIMBER.CO.NZ - PHONE 0800NZTIMBER	SHOWROOM 51 COMMERCE ST WHANGAREI 0110 NEW ZEALAND	

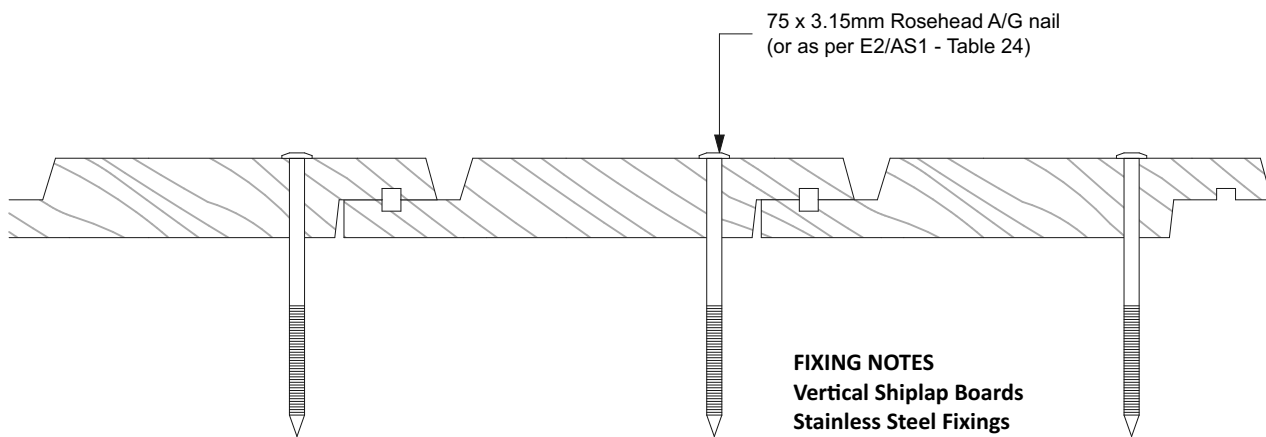
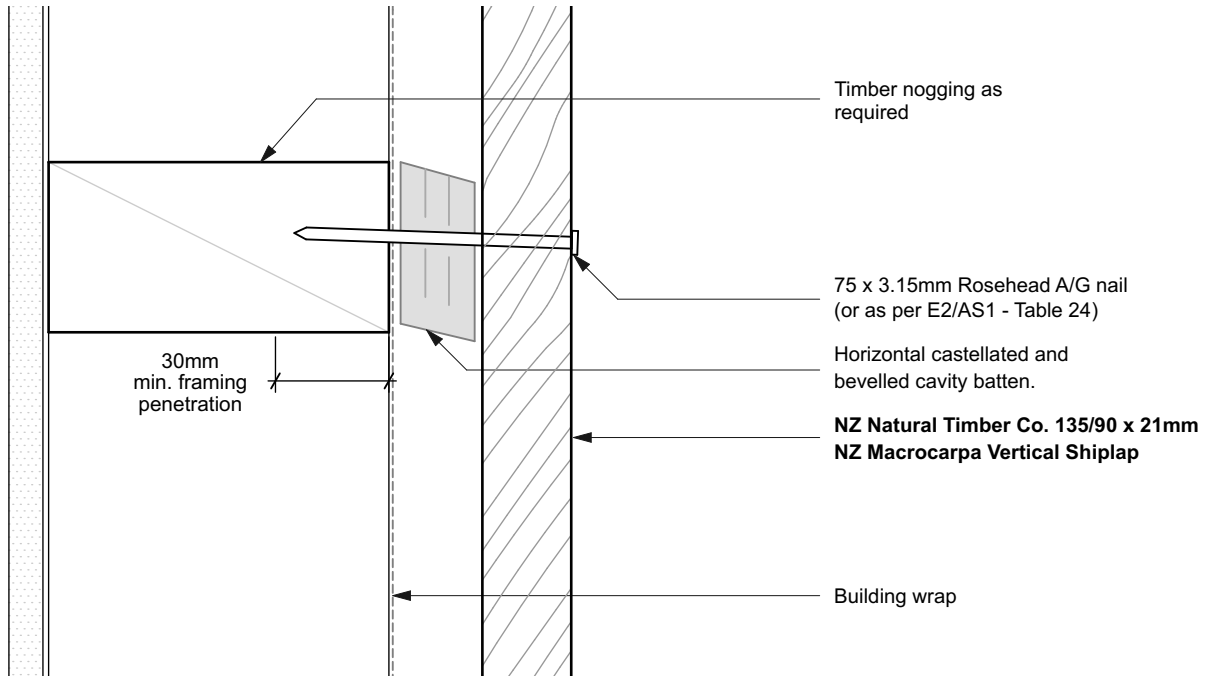

FIXING NOTES

**Vertical Shiplap Boards
Stainless Steel Fixings**

- Rosehead A/G 100 x 4.0mm
- Rosehead A/G 75 x 3.15mm
- Rosehead A/G 60 x 3.15mm
- Rosehead A/G 38 x 3.15mm

Silicone Bronze Fixings

- Rosehead A/G 100 x 4.0mm
- Rosehead A/G 75 x 3.25mm
- Rosehead A/G 60 x 3.25mm
- Rosehead A/G 38 x 3.25mm

NOTES

- All nail fixings pre-drilled min. 1mm diameter smaller than the nail gauge.
- All NZ Natural Timber Co. timber products to be pre-coated and cut ends and edges and all fresh cut surfaces double coated and sealed before fixing.
- All corner flashings to be 75 x 75mm to suit all wind zones. All flashings to have hemmed edges to NZBC E2/AS1.
- Avoid contact in seaspray zones or corrosion zone D between CCA treated timber and metal flashings. Refer NZBC E2/AS1 Table 21

NT-MC.02 Vertical Shiplap Weatherboard System. Cavity Fix		SCALE 1:2 @ A4
DRAWING	Detail Cavity Fix	02

	SUSTAINABLE BESPOKE TIMBERS - COMMERCIAL & RESIDENTIAL		 FULL SERVICE
	WWW.NZNATURALTIMBER.CO.NZ SALES@NZNATURALTIMBER.CO.NZ - PHONE 0800NZTIMBER	SHOWROOM 51 COMMERCE ST WHANGAREI 0110 NEW ZEALAND	

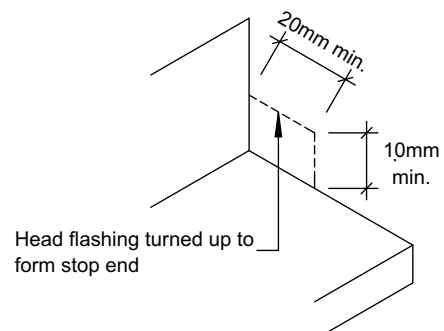
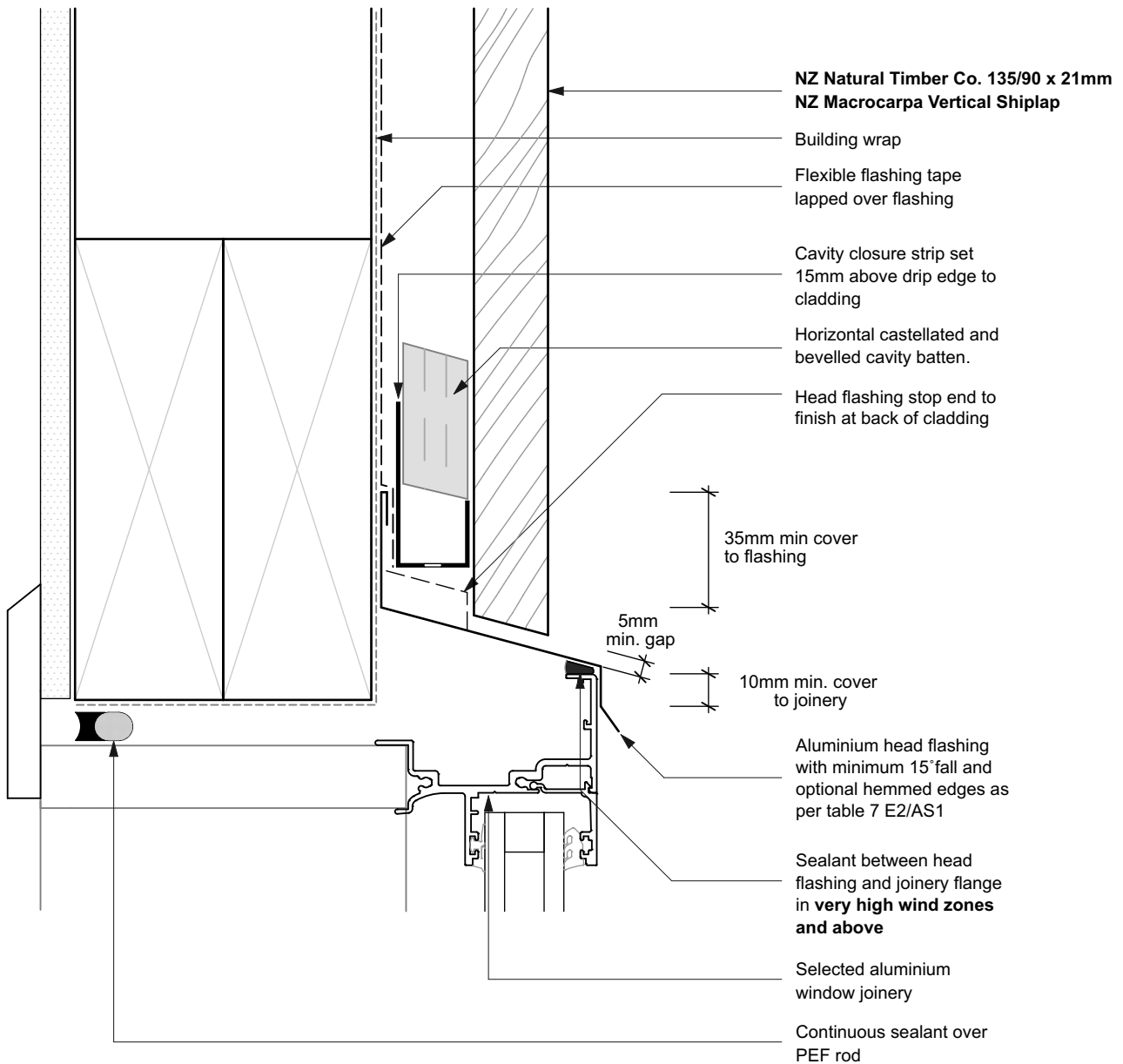

NOTES

- All nail fixings pre-drilled min. 1mm diameter smaller than the nail gauge.
- All NZ Natural Timber Co. timber products to be pre-coated and cut ends and edges and all fresh cut surfaces double coated and sealed before fixing.
- All corner flashings to be 75 x 75mm to suit all wind zones. All flashings to have hemmed edges to NZBC E2/AS1.
- Avoid contact in seaspray zones or corrosion zone D between CCA treated timber and metal flashings. Refer NZBC E2/AS1 Table 21

NT-MC.02 Vertical Shiplap Weatherboard System. Cavity Fix		SCALE 1:2 @ A4
DRAWING Window Head Detail	03	

	SUSTAINABLE BESPOKE TIMBERS - COMMERCIAL & RESIDENTIAL		 FULL SERVICE
	WWW.NZNATURALTIMBER.CO.NZ SALES@NZNATURALTIMBER.CO.NZ - PHONE 0800NZTIMBER	SHOWROOM 51 COMMERCE ST WHANGAREI 0110 NEW ZEALAND	

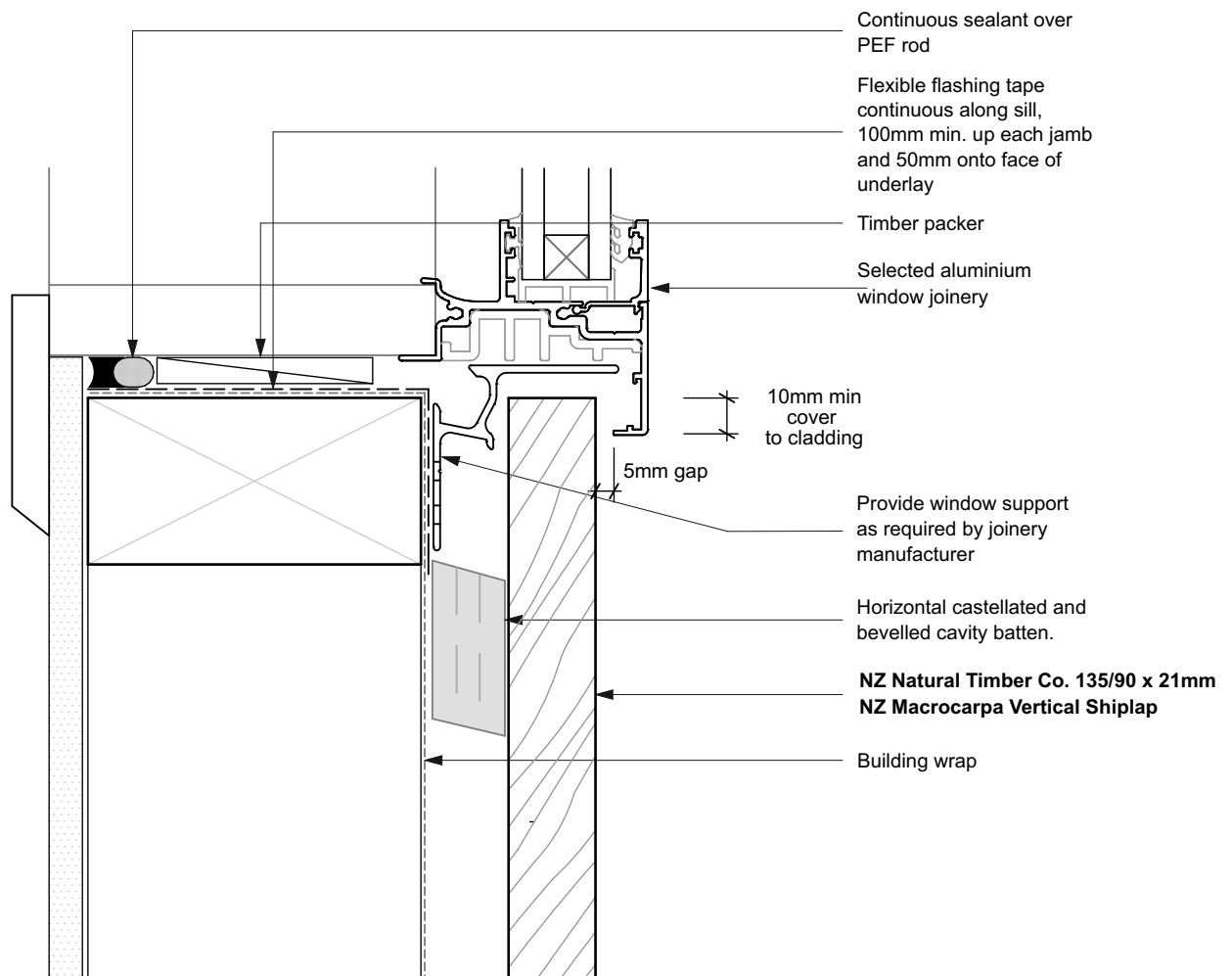

NOTES

- All nail fixings pre-drilled min. 1mm diameter smaller than the nail gauge.
- All NZ Natural Timber Co. timber products to be pre-coated and cut ends and edges and all fresh cut surfaces double coated and sealed before fixing.
- All corner flashings to be 75 x 75mm to suit all wind zones. All flashings to have hemmed edges to NZBC E2/AS1.
- Avoid contact in seaspray zones or corrosion zone D between CCA treated timber and metal flashings. Refer NZBC E2/AS1 Table 21

NT-MC.02 Vertical Shiplap Weatherboard System. Cavity Fix		SCALE 1:2 @ A4
DRAWING	Window Sill Detail	04

	SUSTAINABLE BESPOKE TIMBERS - COMMERCIAL & RESIDENTIAL		 FULL SERVICE
	WWW.NZNATURALTIMBER.CO.NZ SALES@NZNATURALTIMBER.CO.NZ - PHONE 0800NZTIMBER	SHOWROOM 51 COMMERCE ST WHANGAREI 0110 NEW ZEALAND	

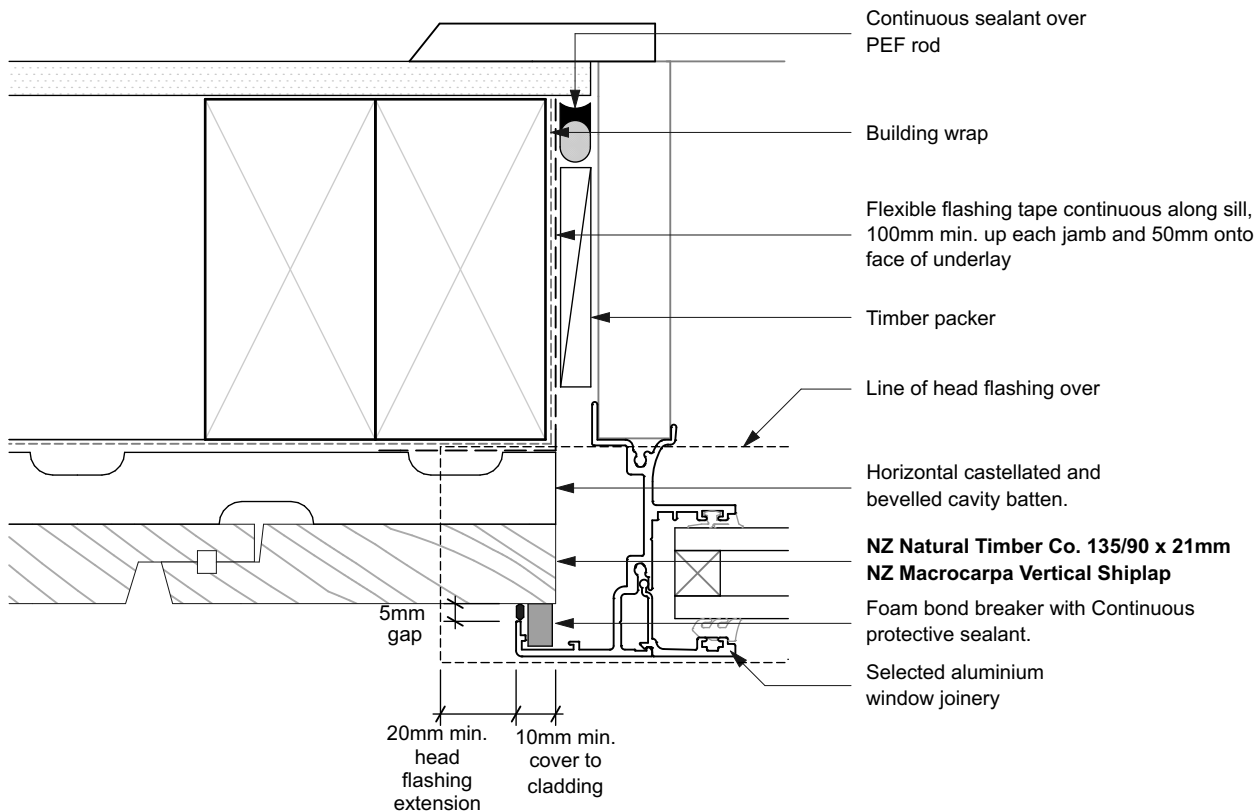

NOTES

- All nail fixings pre-drilled min. 1mm diameter smaller than the nail gauge.
- All NZ Natural Timber Co. timber products to be pre-coated and cut ends and edges and all fresh cut surfaces double coated and sealed before fixing.
- All corner flashings to be 75 x 75mm to suit all wind zones. All flashings to have hemmed edges to NZBC E2/AS1.
- Avoid contact in seaspray zones or corrosion zone D between CCA treated timber and metal flashings. Refer NZBC E2/AS1 Table 21

NT-MC.02 Vertical Shiplap Weatherboard System. Cavity Fix		SCALE 1:2 @ A4
DRAWING	Window Jamb Detail	05

	SUSTAINABLE BESPOKE TIMBERS - COMMERCIAL & RESIDENTIAL		
	WWW.NZNATURALTIMBER.CO.NZ SALES@NZNATURALTIMBER.CO.NZ - PHONE 0800NZTIMBER	SHOWROOM 51 COMMERCE ST WHANGAREI 0110 NEW ZEALAND	

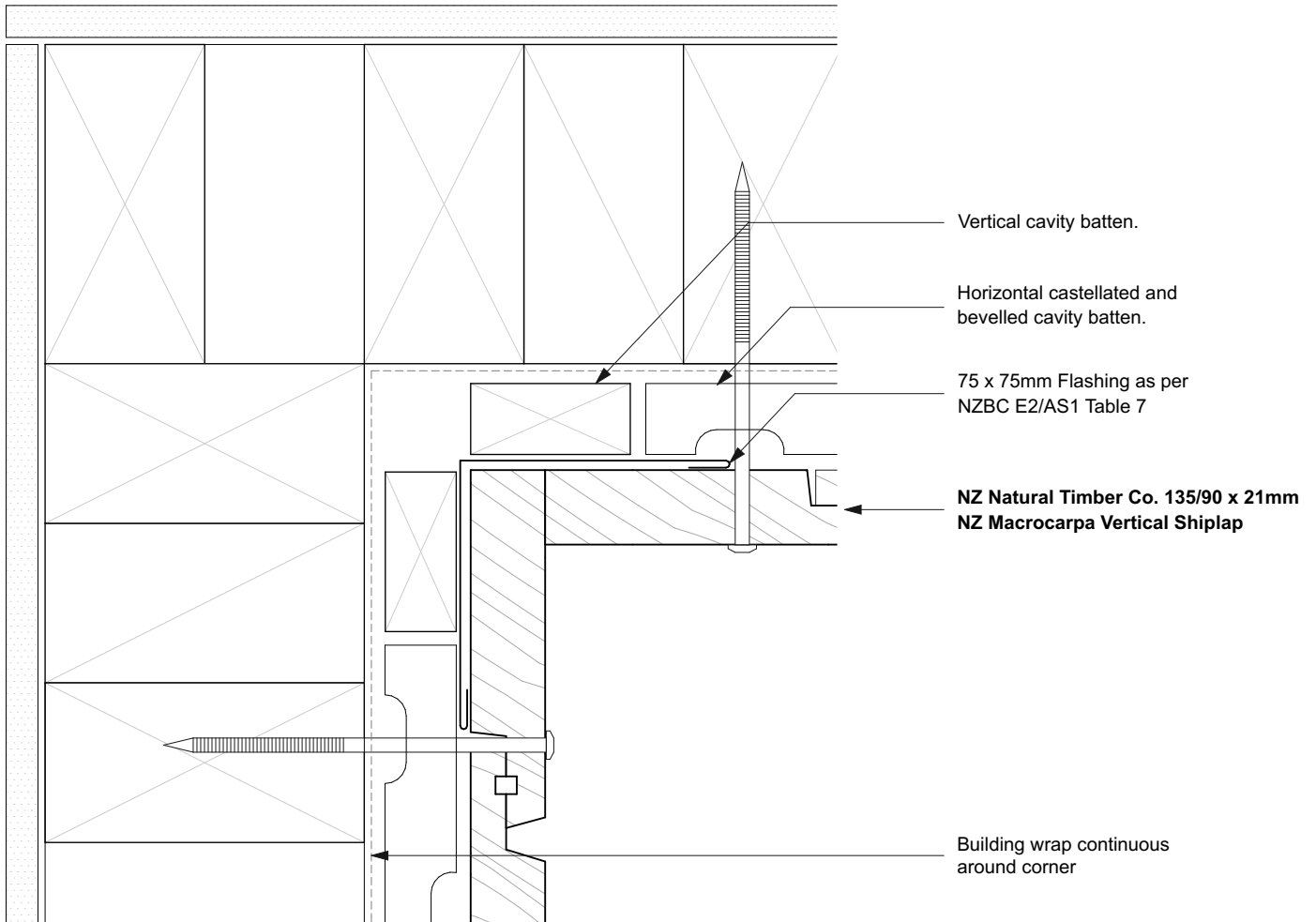

NOTES

- All nail fixings pre-drilled min. 1mm diameter smaller than the nail gauge.
- All NZ Natural Timber Co. timber products to be pre-coated and cut ends and edges and all fresh cut surfaces double coated and sealed before fixing.
- All corner flashings to be 75 x 75mm to suit all wind zones. All flashings to have hemmed edges to NZBC E2/AS1.
- Avoid contact in seaspray zones or corrosion zone D between CCA treated timber and metal flashings. Refer NZBC E2/AS1 Table 21

NT-MC.02 Vertical Shiplap Weatherboard System. Cavity Fix		SCALE 1:2 @ A4
DRAWING	Internal Corner Edge to Edge	06

	SUSTAINABLE BESPOKE TIMBERS - COMMERCIAL & RESIDENTIAL		
	WWW.NZNATURALTIMBER.CO.NZ SALES@NZNATURALTIMBER.CO.NZ - PHONE 0800NZTIMBER	SHOWROOM 51 COMMERCE ST WHANGAREI 0110 NEW ZEALAND	

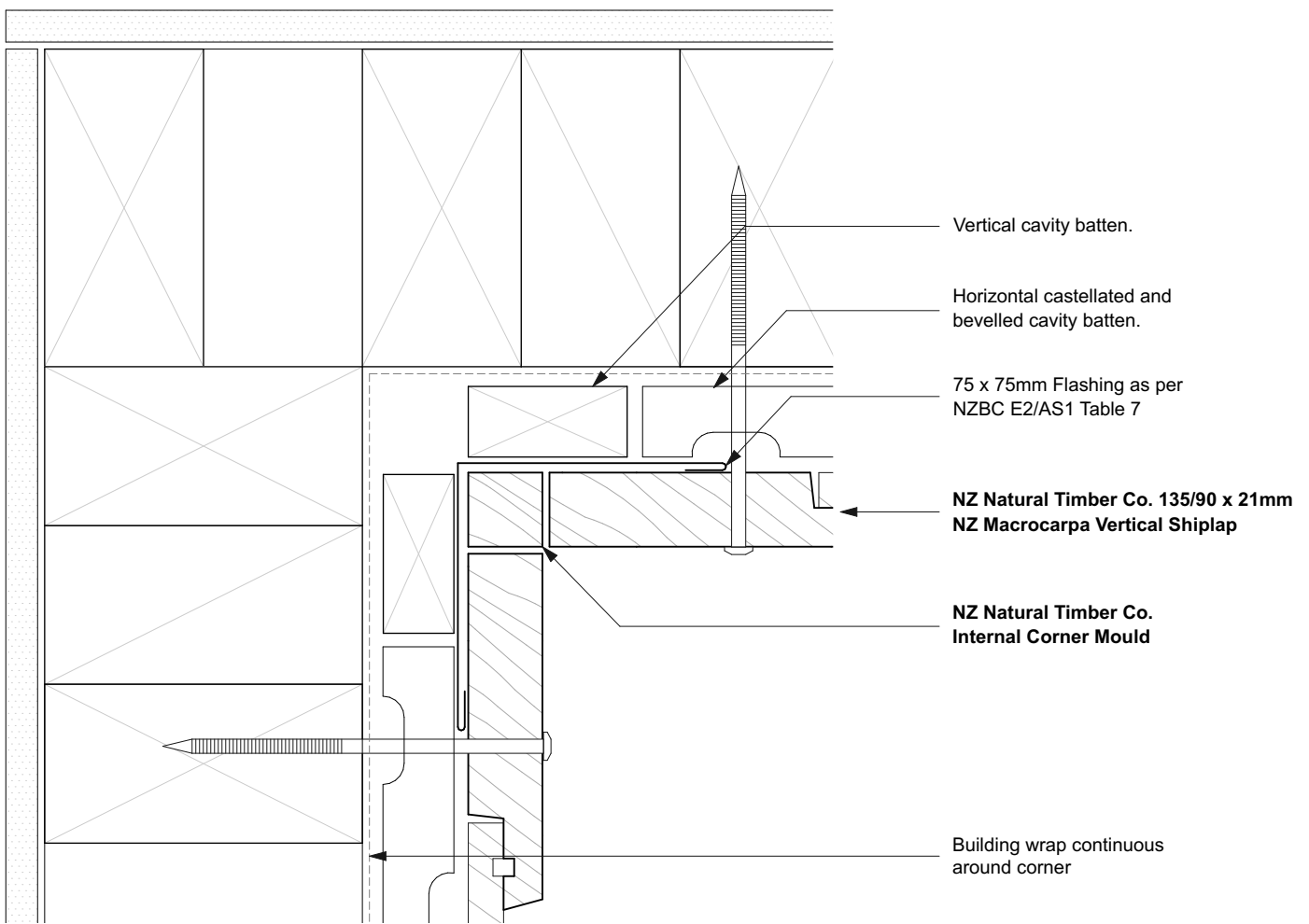

NOTES

- All nail fixings pre-drilled min. 1mm diameter smaller than the nail gauge.
- All NZ Natural Timber Co. timber products to be pre-coated and cut ends and edges and all fresh cut surfaces double coated and sealed before fixing.
- All corner flashings to be 75 x 75mm to suit all wind zones. All flashings to have hemmed edges to NZBC E2/AS1.
- Avoid contact in seaspray zones or corrosion zone D between CCA treated timber and metal flashings. Refer NZBC E2/AS1 Table 21

NT-MC.02 Vertical Shiplap Weatherboard System. Cavity Fix		SCALE 1:2 @ A4
DRAWING	Internal Corner	07

	SUSTAINABLE BESPOKE TIMBERS - COMMERCIAL & RESIDENTIAL		
	WWW.NZNATURALTIMBER.CO.NZ SALES@NZNATURALTIMBER.CO.NZ - PHONE 0800NZTIMBER	SHOWROOM 51 COMMERCE ST WHANGAREI 0110 NEW ZEALAND	

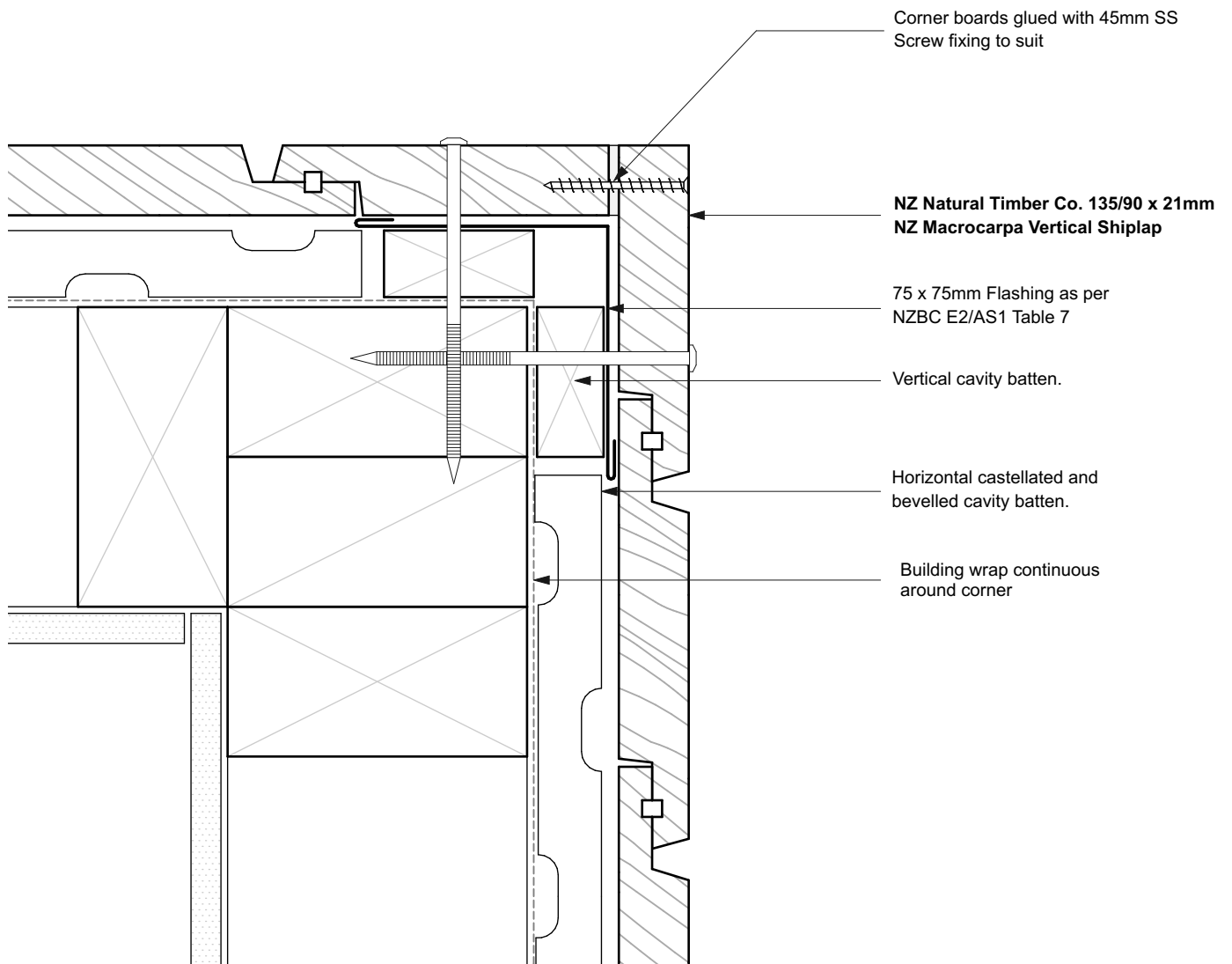

NOTES

- All nail fixings pre-drilled min. 1mm diameter smaller than the nail gauge.
- All NZ Natural Timber Co. timber products to be pre-coated and cut ends and edges and all fresh cut surfaces double coated and sealed before fixing.
- All corner flashings to be 75 x 75mm to suit all wind zones. All flashings to have hemmed edges to NZBC E2/AS1.
- Avoid contact in seaspray zones or corrosion zone D between CCA treated timber and metal flashings. Refer NZBC E2/AS1 Table 21

NT-MC.02 Vertical Shiplap Weatherboard System. Cavity Fix		SCALE 1:2 @ A4
DRAWING	External Corner	08

	SUSTAINABLE BESPOKE TIMBERS - COMMERCIAL & RESIDENTIAL		
	WWW.NZNATURALTIMBER.CO.NZ SALES@NZNATURALTIMBER.CO.NZ - PHONE 0800NZTIMBER	SHOWROOM 51 COMMERCE ST WHANGAREI 0110 NEW ZEALAND	

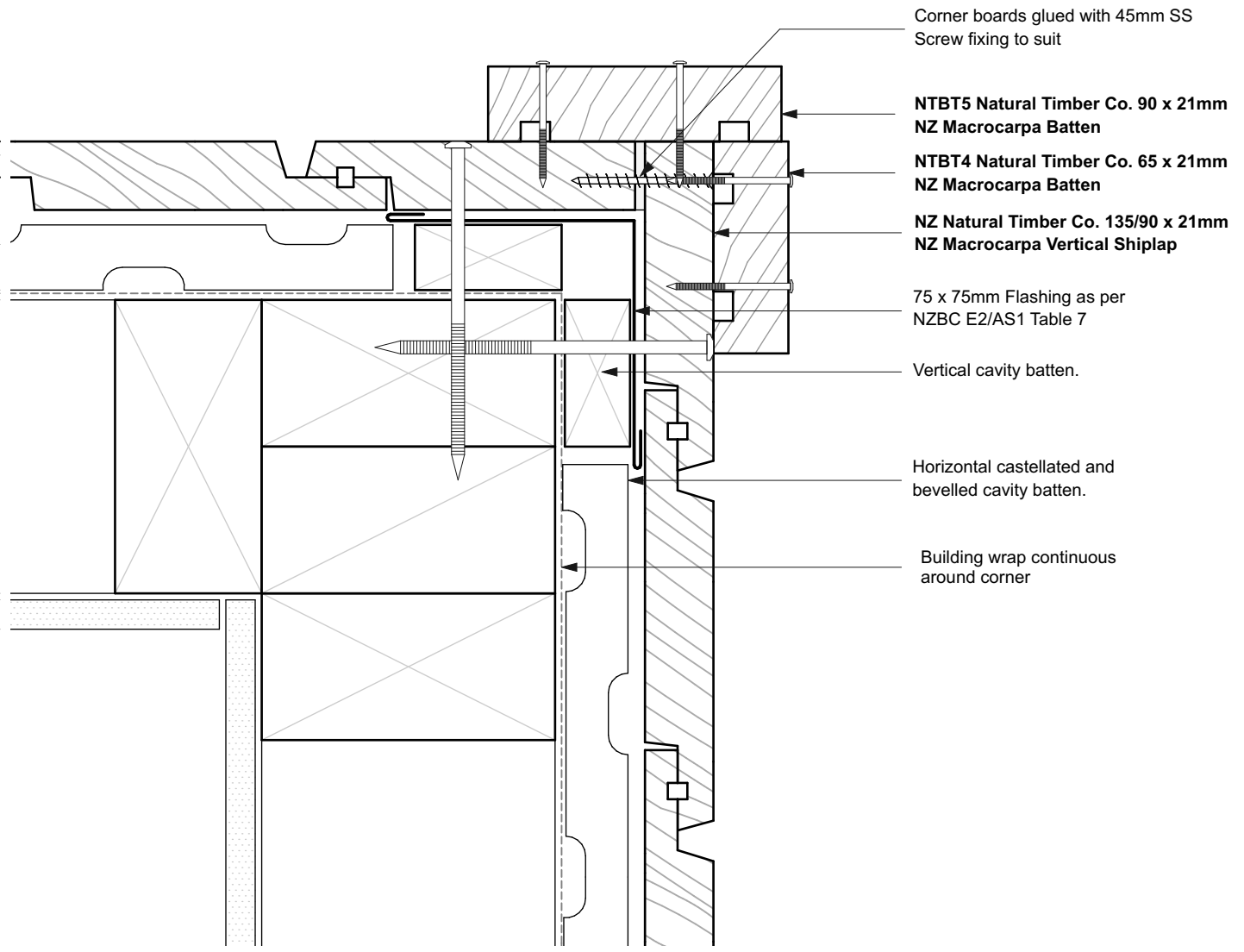

NOTES

- All nail fixings pre-drilled min. 1mm diameter smaller than the nail gauge.
- All NZ Natural Timber Co. timber products to be pre-coated and cut ends and edges and all fresh cut surfaces double coated and sealed before fixing.
- All corner flashings to be 75 x 75mm to suit all wind zones. All flashings to have hemmed edges to NZBC E2/AS1.
- Avoid contact in seaspray zones or corrosion zone D between CCA treated timber and metal flashings. Refer NZBC E2/AS1 Table 21

NT-MC.02 Vertical Shiplap Weatherboard System. Cavity Fix		SCALE 1:2 @ A4
DRAWING External Corner Boxed		09

	SUSTAINABLE BESPOKE TIMBERS - COMMERCIAL & RESIDENTIAL		 FULL SERVICE
	WWW.NZNATURALTIMBER.CO.NZ SALES@NZNATURALTIMBER.CO.NZ - PHONE 0800NZTIMBER	SHOWROOM 51 COMMERCE ST WHANGAREI 0110 NEW ZEALAND	

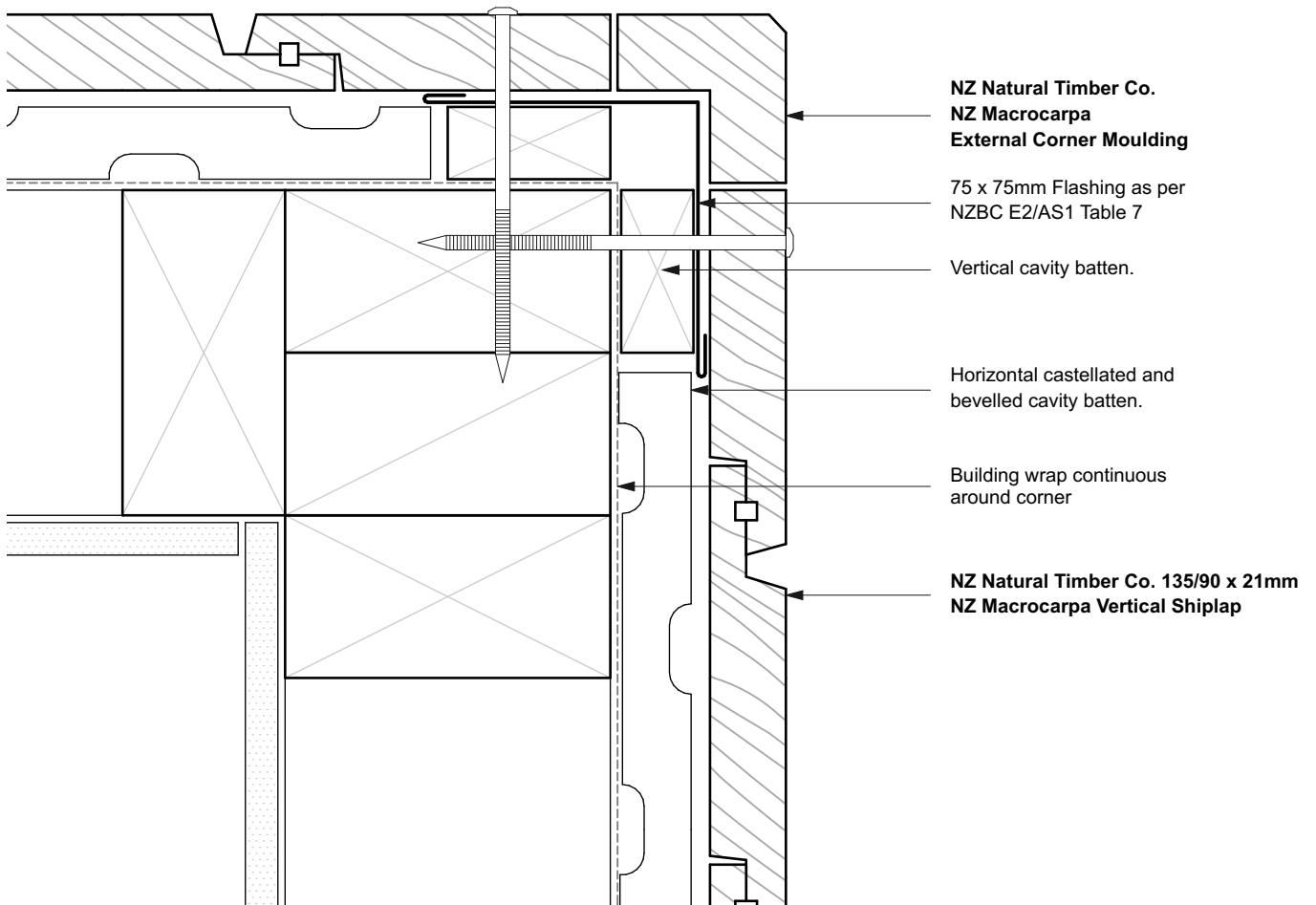

NOTES

- All nail fixings pre-drilled min. 1mm diameter smaller than the nail gauge.
- All NZ Natural Timber Co. timber products to be pre-coated and cut ends and edges and all fresh cut surfaces double coated and sealed before fixing.
- All corner flashings to be 75 x 75mm to suit all wind zones. All flashings to have hemmed edges to NZBC E2/AS1.
- Avoid contact in seaspray zones or corrosion zone D between CCA treated timber and metal flashings. Refer NZBC E2/AS1 Table 21

NT-MC.02 Vertical Shiplap Weatherboard System. Cavity Fix	SCALE 1:2 @ A4
DRAWING External Corner Moulding	10

	SUSTAINABLE BESPOKE TIMBERS - COMMERCIAL & RESIDENTIAL		
	WWW.NZNATURALTIMBER.CO.NZ SALES@NZNATURALTIMBER.CO.NZ - PHONE 0800NZTIMBER	SHOWROOM 51 COMMERCE ST WHANGAREI 0110 NEW ZEALAND	

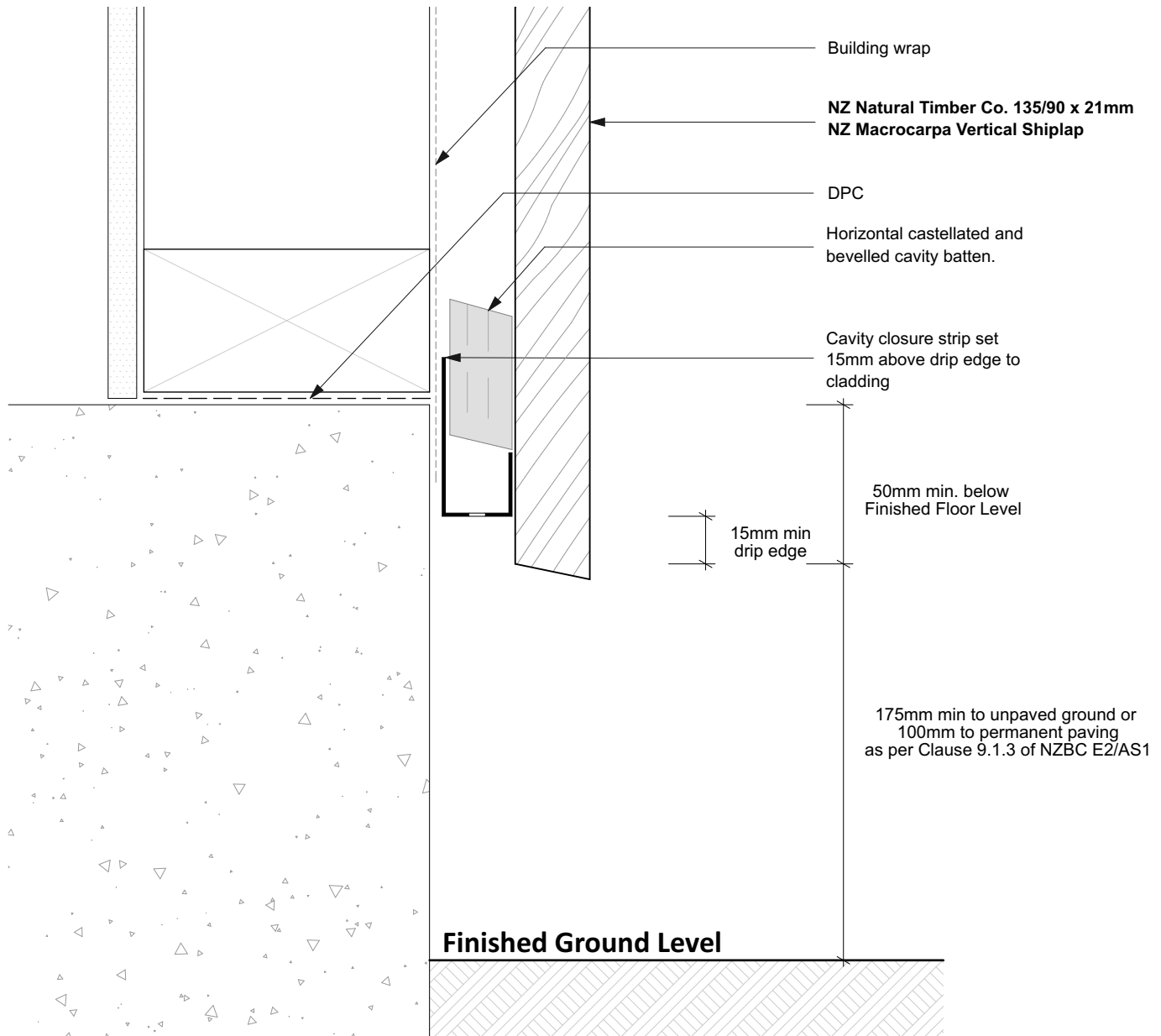

NOTES

- All nail fixings pre-drilled min. 1mm diameter smaller than the nail gauge.
- All NZ Natural Timber Co. timber products to be pre-coated and cut ends and edges and all fresh cut surfaces double coated and sealed before fixing.
- All corner flashings to be 75 x 75mm to suit all wind zones. All flashings to have hemmed edges to NZBC E2/AS1.
- Avoid contact in seaspray zones or corrosion zone D between CCA treated timber and metal flashings. Refer NZBC E2/AS1 Table 21

NT-MC.02 Vertical Shiplap Weatherboard System. Cavity Fix		SCALE 1:2 @ A4
DRAWING Base of Wall - Concrete		11

	SUSTAINABLE BESPOKE TIMBERS - COMMERCIAL & RESIDENTIAL		 FULL SERVICE
	WWW.NZNATURALTIMBER.CO.NZ SALES@NZNATURALTIMBER.CO.NZ - PHONE 0800NZTIMBER	SHOWROOM 51 COMMERCE ST WHANGAREI 0110 NEW ZEALAND	

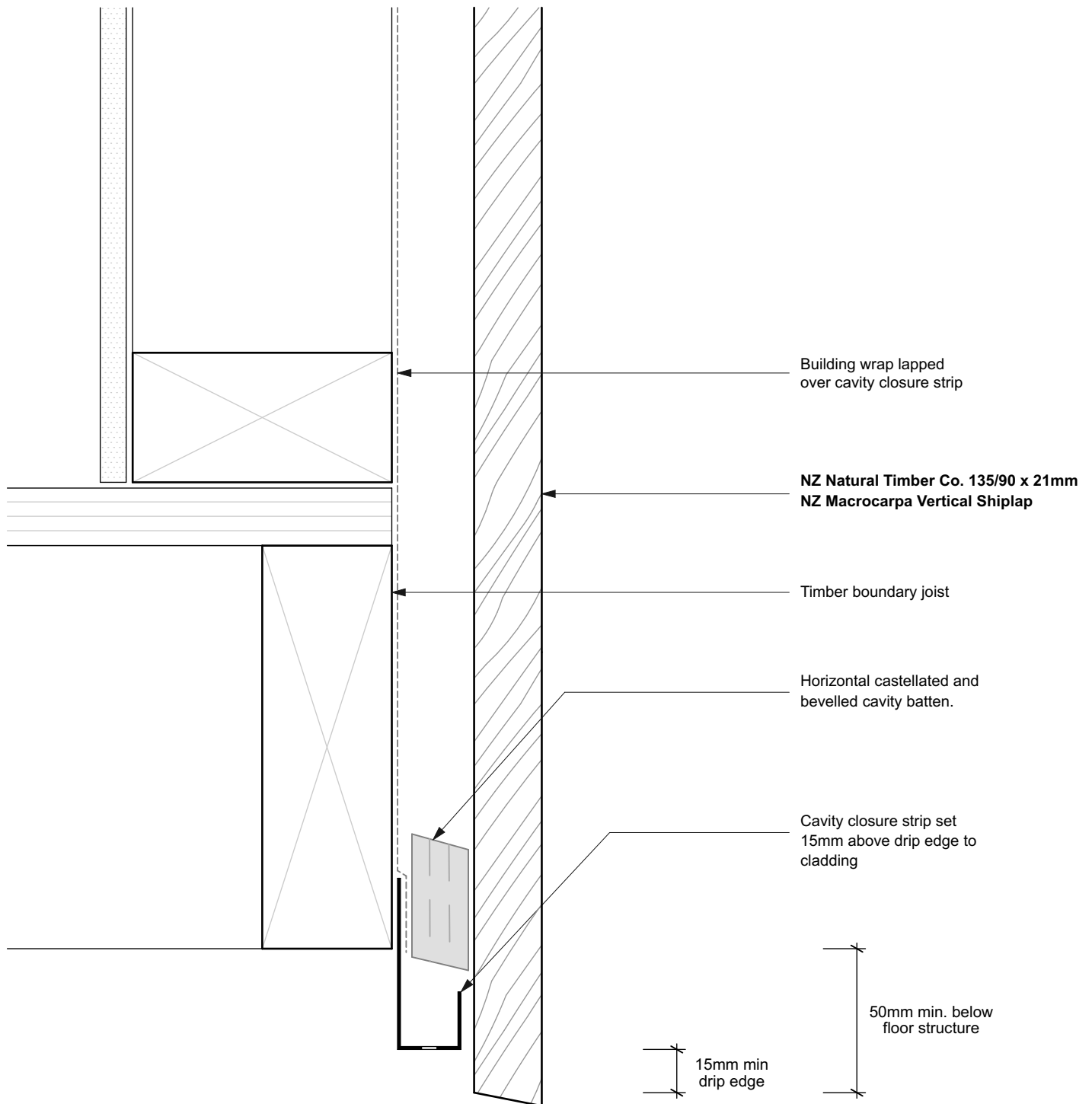

NOTES

- All nail fixings pre-drilled min. 1mm diameter smaller than the nail gauge.
- All NZ Natural Timber Co. timber products to be pre-coated and cut ends and edges and all fresh cut surfaces double coated and sealed before fixing.
- All corner flashings to be 75 x 75mm to suit all wind zones. All flashings to have hemmed edges to NZBC E2/AS1.
- Avoid contact in seaspray zones or corrosion zone D between CCA treated timber and metal flashings. Refer NZBC E2/AS1 Table 21

NT-MC.02 Vertical Shiplap Weatherboard System. Cavity Fix		SCALE 1:2 @ A4
DRAWING	Base of Wall - Timber	12

	SUSTAINABLE BESPOKE TIMBERS - COMMERCIAL & RESIDENTIAL		 FULL SERVICE
	WWW.NZNATURALTIMBER.CO.NZ SALES@NZNATURALTIMBER.CO.NZ - PHONE 0800NZTIMBER	SHOWROOM 51 COMMERCE ST WHANGAREI 0110 NEW ZEALAND	

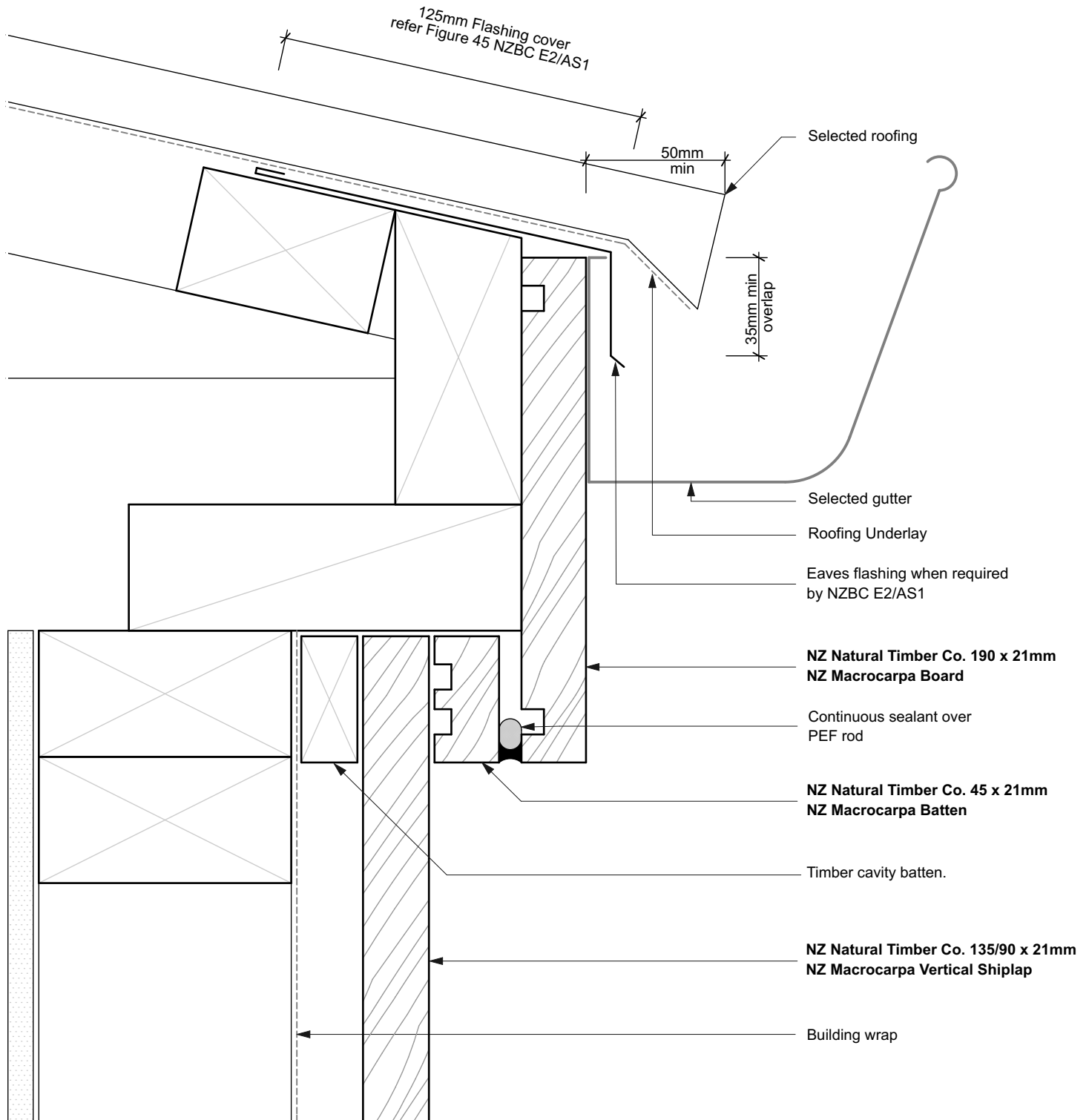

NOTES

- All nail fixings pre-drilled min. 1mm diameter smaller than the nail gauge.
- All NZ Natural Timber Co. timber products to be pre-coated and cut ends and edges and all fresh cut surfaces double coated and sealed before fixing.
- All corner flashings to be 75 x 75mm to suit all wind zones. All flashings to have hemmed edges to NZBC E2/AS1.
- Avoid contact in seaspray zones or corrosion zone D between CCA treated timber and metal flashings. Refer NZBC E2/AS1 Table 21

NT-MC.02 Vertical Shiplap Weatherboard System. Cavity Fix		SCALE 1:2 @ A4
DRAWING	Eaves Detail	14

	SUSTAINABLE BESPOKE TIMBERS - COMMERCIAL & RESIDENTIAL		
	WWW.NZNATURALTIMBER.CO.NZ SALES@NZNATURALTIMBER.CO.NZ - PHONE 0800NZTIMBER	SHOWROOM 51 COMMERCE ST WHANGAREI 0110 NEW ZEALAND	

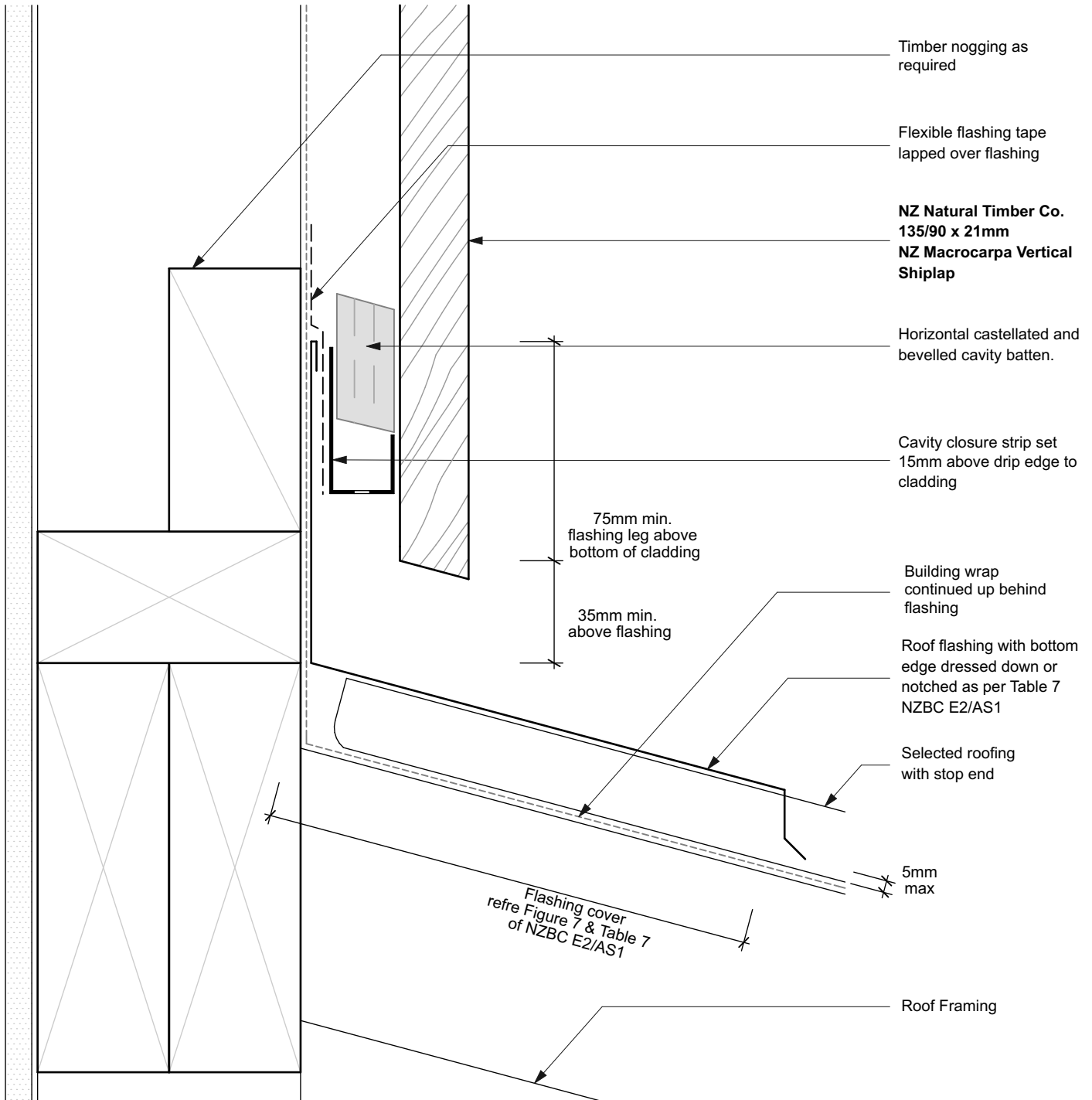

NOTES

- All nail fixings pre-drilled min. 1mm diameter smaller than the nail gauge.
- All NZ Natural Timber Co. timber products to be pre-coated and cut ends and edges and all fresh cut surfaces double coated and sealed before fixing.
- All corner flashings to be 75 x 75mm to suit all wind zones. All flashings to have hemmed edges to NZBC E2/AS1.
- Avoid contact in seaspray zones or corrosion zone D between CCA treated timber and metal flashings. Refer NZBC E2/AS1 Table 21

NT-MC.02 Vertical Shiplap Weatherboard System. Cavity Fix		SCALE 1:2 @ A4
DRAWING Roof/Wall Junction Detail		15

	SUSTAINABLE BESPOKE TIMBERS - COMMERCIAL & RESIDENTIAL		
	WWW.NZNATURALTIMBER.CO.NZ SALES@NZNATURALTIMBER.CO.NZ - PHONE 0800NZTIMBER	SHOWROOM 51 COMMERCE ST WHANGAREI 0110 NEW ZEALAND	

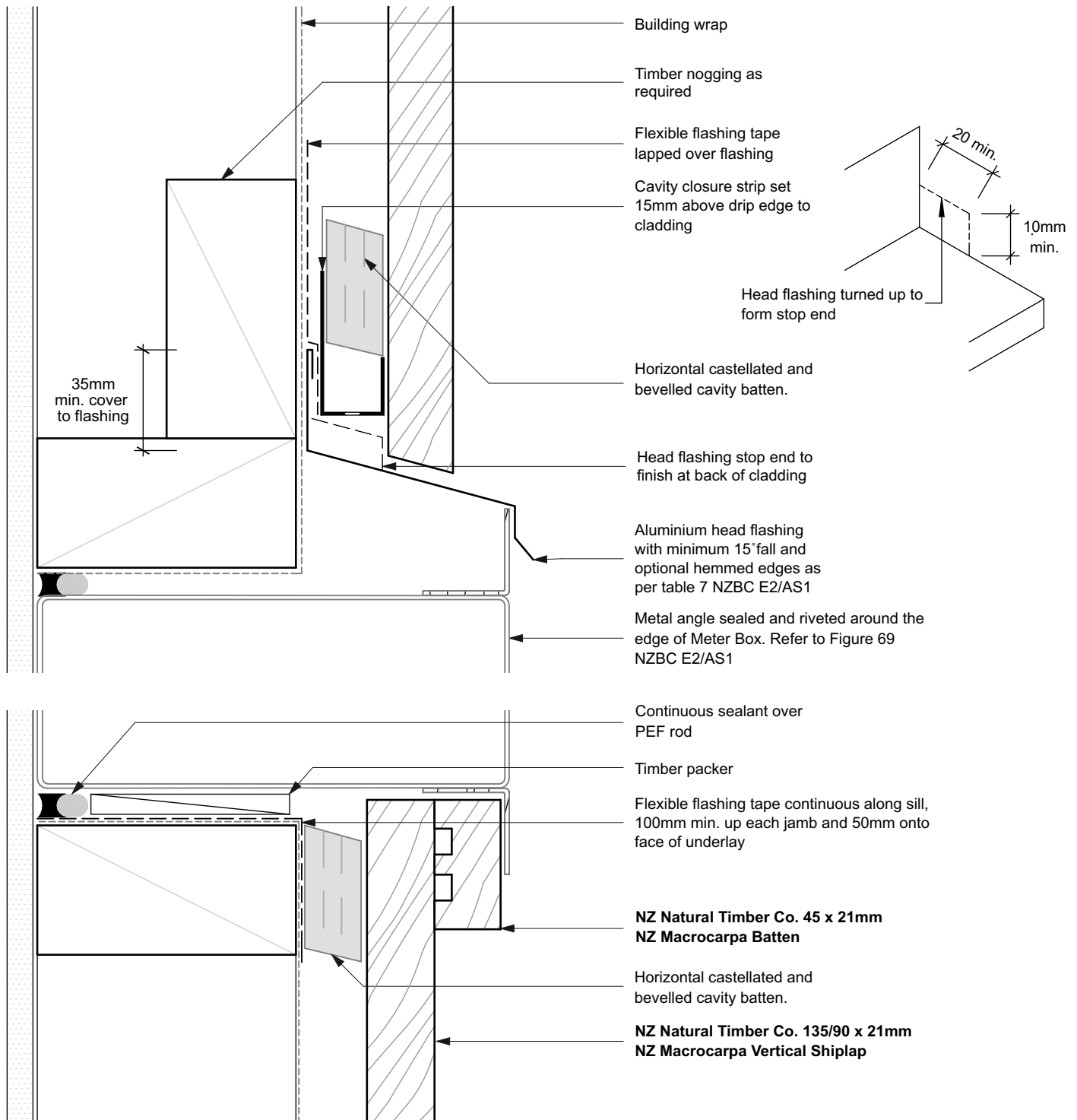

NOTES

- All nail fixings pre-drilled min. 1mm diameter smaller than the nail gauge.
- All NZ Natural Timber Co. timber products to be pre-coated and cut ends and edges and all fresh cut surfaces double coated and sealed before fixing.
- All corner flashings to be 75 x 75mm to suit all wind zones. All flashings to have hemmed edges to NZBC E2/AS1.
- Avoid contact in seaspray zones or corrosion zone D between CCA treated timber and metal flashings. Refer NZBC E2/AS1 Table 21

NT-MC.02 Vertical Shiplap Weatherboard System. Cavity Fix		SCALE 1:2 @ A4
DRAWING	Meter Box Detail	16