

	SUSTAINABLE BESPOKE TIMBERS - COMMERCIAL & RESIDENTIAL		⇒
	WWW.NZNATURALTIMBER.CO.NZ SALES@NZNATURALTIMBER.CO.NZ - PHONE 0800NZTIMBER	SHOWROOM 51 COMMERCE ST WHANGAREI 0110 NEW ZEALAND	FULL SERVICE

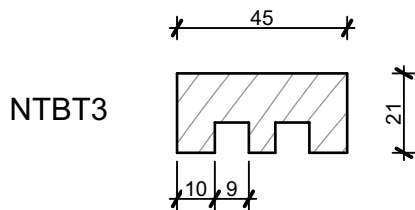

NTBT3

**NTBT3 Natural Timber Co. 45 x 21mm
NZ Lawsons Cypress Batten**

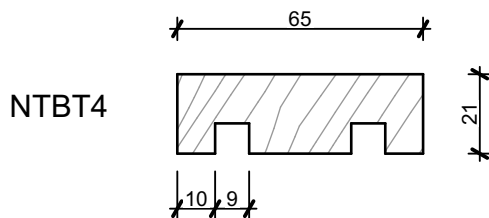

NTBT4

**NTBT4 Natural Timber Co. 65 x 21mm
NZ Lawsons Cypress Batten**

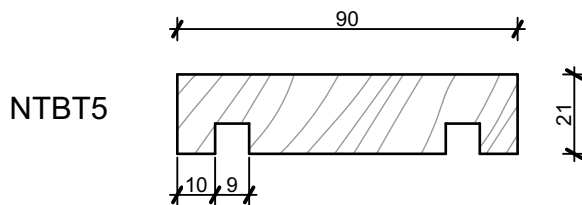

NTBT5

**NTBT5 Natural Timber Co. 90 x 21mm
NZ Lawsons Cypress Batten**

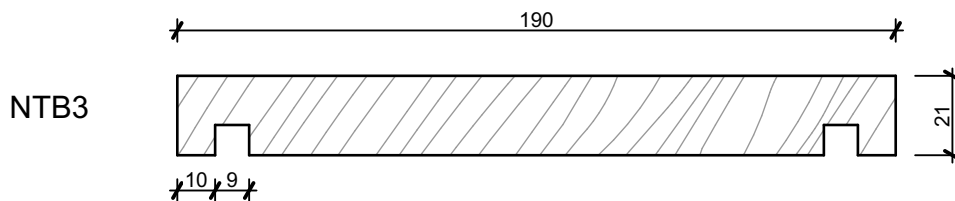

NTB3

**NTB3 Natural Timber Co. 190 x 21mm
NZ Lawsons Cypress Board**

NOTES

- All nail fixings pre-drilled min. 1mm diameter smaller than the nail gauge.
- All NZ Natural Timber Co. timber products to be pre-coated and cut ends and edges and all fresh cut surfaces double coated and sealed before fixing.
- All corner flashings to be 75 x 75mm to suit all wind zones. All flashings to have hemmed edges to NZBC E2/AS1.
- Avoid contact in seaspray zones or corrosion zone D between CCA treated timber and metal flashings. Refer NZBC E2/AS1 Table 21

NT-LC.02 Board & Batten Weatherboard System. Cavity Fix		SCALE 1:2 @ A4
DRAWING Board and Batten Profiles		01

	SUSTAINABLE BESPOKE TIMBERS - COMMERCIAL & RESIDENTIAL		 FULL SERVICE
	WWW.NZNATURALTIMBER.CO.NZ SALES@NZNATURALTIMBER.CO.NZ - PHONE 0800NZTIMBER	SHOWROOM 51 COMMERCE ST WHANGAREI 0110 NEW ZEALAND	

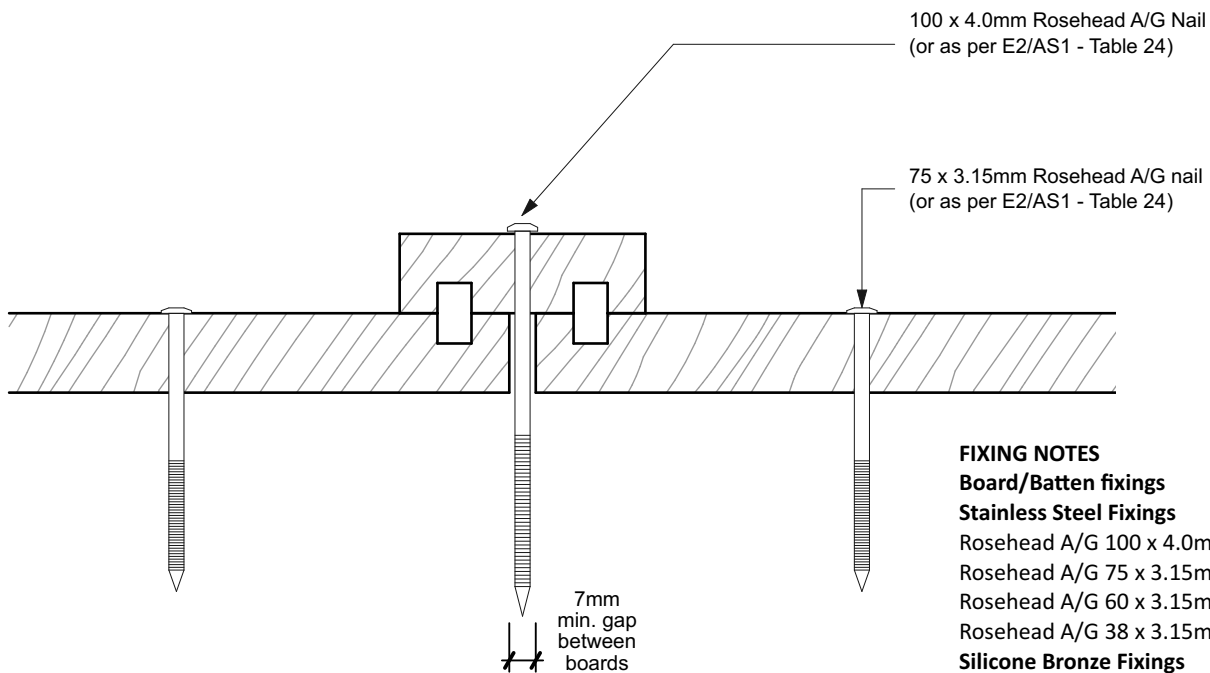
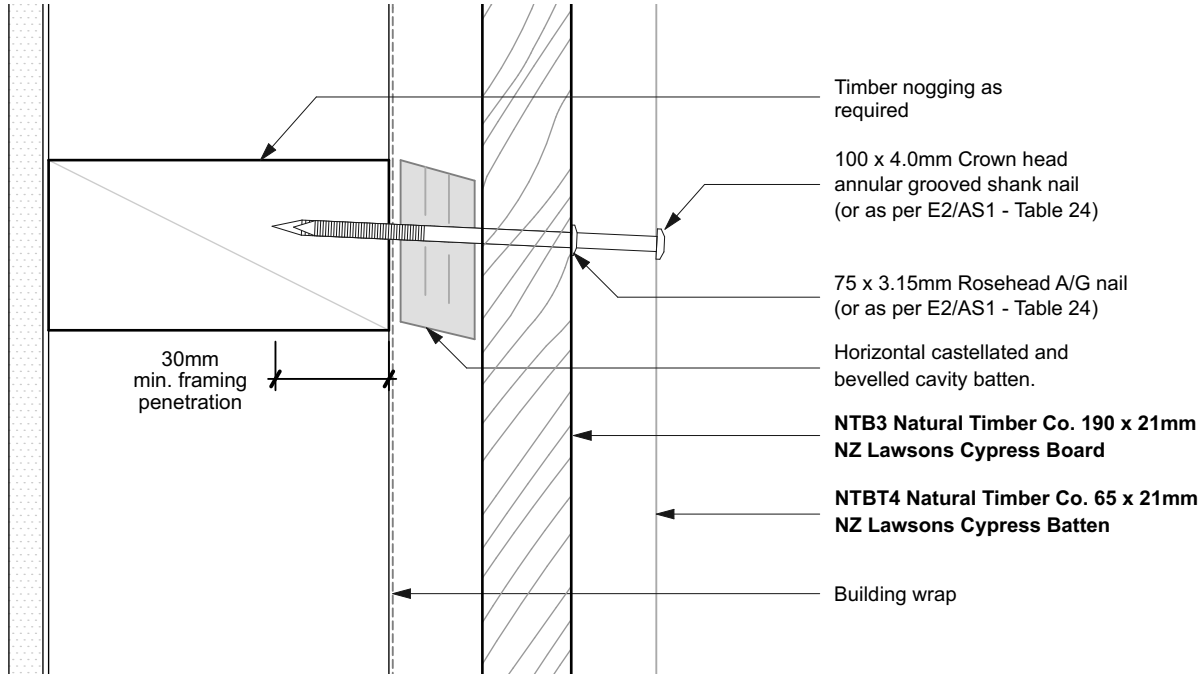

FIXING NOTES

Board/Batten fixings

Stainless Steel Fixings

Rosehead A/G 100 x 4.0mm

Rosehead A/G 75 x 3.15mm

Rosehead A/G 60 x 3.15mm

Rosehead A/G 38 x 3.15mm

Silicone Bronze Fixings

Rosehead A/G 100 x 4.0mm

Rosehead A/G 75 x 3.25mm

Rosehead A/G 60 x 3.25mm

Rosehead A/G 38 x 3.25mm

NOTES

- All nail fixings pre-drilled min. 1mm diameter smaller than the nail gauge.
- All NZ Natural Timber Co. timber products to be pre-coated and cut ends and edges and all fresh cut surfaces double coated and sealed before fixing.
- All corner flashings to be 75 x 75mm to suit all wind zones. All flashings to have hemmed edges to NZBC E2/AS1.
- Avoid contact in seaspray zones or corrosion zone D between CCA treated timber and metal flashings. Refer NZBC E2/AS1 Table 21

NT-LC.02 Board & Batten Weatherboard System. Cavity Fix		SCALE 1:2 @ A4
DRAWING	Detail Cavity Fix	02

	SUSTAINABLE BESPOKE TIMBERS - COMMERCIAL & RESIDENTIAL		 FULL SERVICE
	WWW.NZNATURALTIMBER.CO.NZ SALES@NZNATURALTIMBER.CO.NZ - PHONE 0800NZTIMBER	SHOWROOM 51 COMMERCE ST WHANGAREI 0110 NEW ZEALAND	

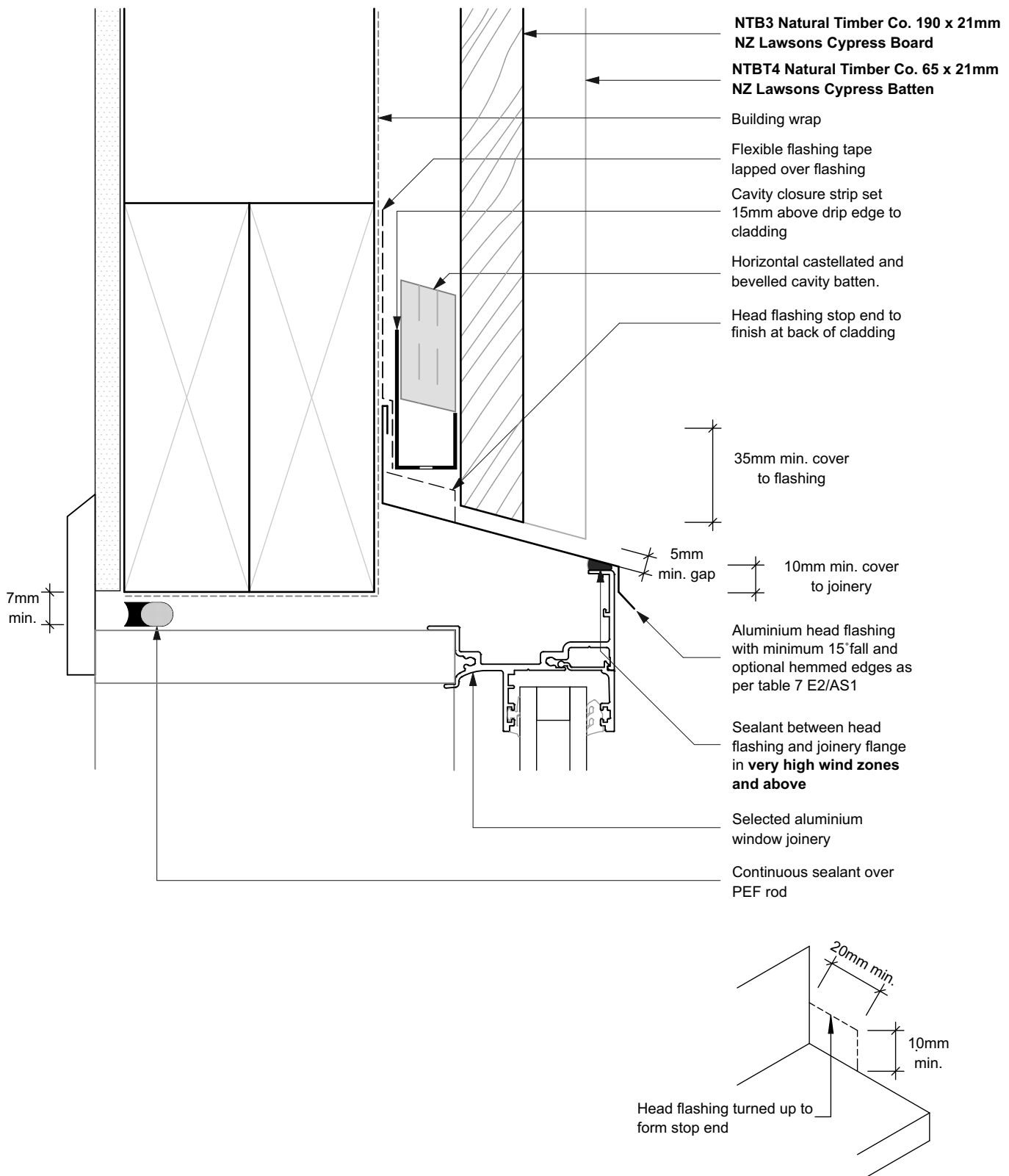

NOTES

- All nail fixings pre-drilled min. 1mm diameter smaller than the nail gauge.
- All NZ Natural Timber Co. timber products to be pre-coated and cut ends and edges and all fresh cut surfaces double coated and sealed before fixing.
- All corner flashings to be 75 x 75mm to suit all wind zones. All flashings to have hemmed edges to NZBC E2/AS1.
- Avoid contact in seaspray zones or corrosion zone D between CCA treated timber and metal flashings. Refer NZBC E2/AS1 Table 21

NT-LC.02 Board & Batten Weatherboard System. Cavity Fix		SCALE 1:2 @ A4
DRAWING Window Head Detail	03	

	SUSTAINABLE BESPOKE TIMBERS - COMMERCIAL & RESIDENTIAL		 FULL SERVICE
	WWW.NZNATURALTIMBER.CO.NZ SALES@NZNATURALTIMBER.CO.NZ - PHONE 0800NZTIMBER	SHOWROOM 51 COMMERCE ST WHANGAREI 0110 NEW ZEALAND	

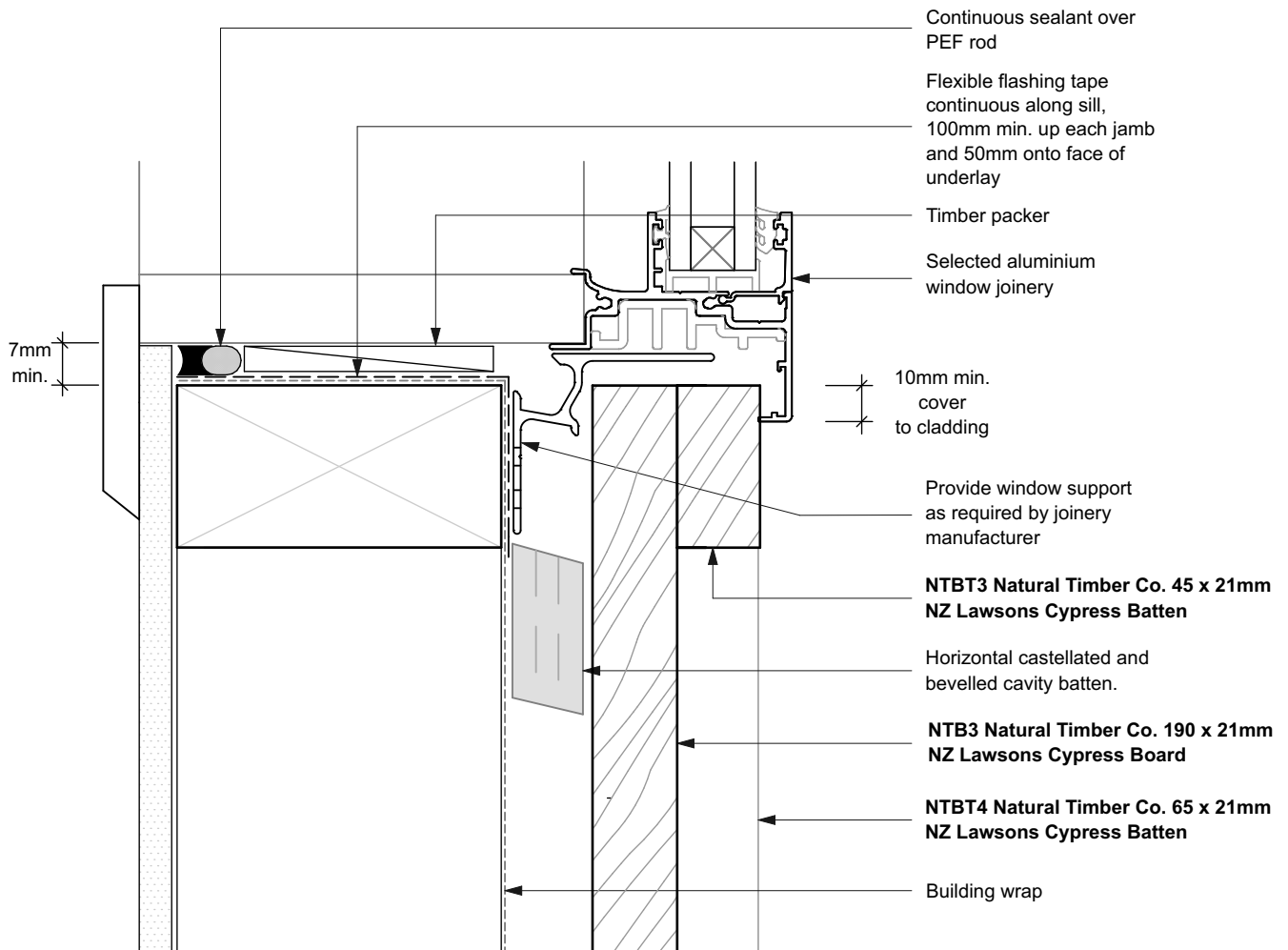

NOTES

- All nail fixings pre-drilled min. 1mm diameter smaller than the nail gauge.
- All NZ Natural Timber Co. timber products to be pre-coated and cut ends and edges and all fresh cut surfaces double coated and sealed before fixing.
- All corner flashings to be 75 x 75mm to suit all wind zones. All flashings to have hemmed edges to NZBC E2/AS1.
- Avoid contact in seaspray zones or corrosion zone D between CCA treated timber and metal flashings. Refer NZBC E2/AS1 Table 21

NT-LC.02 Board & Batten Weatherboard System. Cavity Fix		SCALE 1:2 @ A4
DRAWING	Window Sill Detail	04

	SUSTAINABLE BESPOKE TIMBERS - COMMERCIAL & RESIDENTIAL		 FULL SERVICE
	WWW.NZNATURALTIMBER.CO.NZ SALES@NZNATURALTIMBER.CO.NZ - PHONE 0800NZTIMBER	SHOWROOM 51 COMMERCE ST WHANGAREI 0110 NEW ZEALAND	

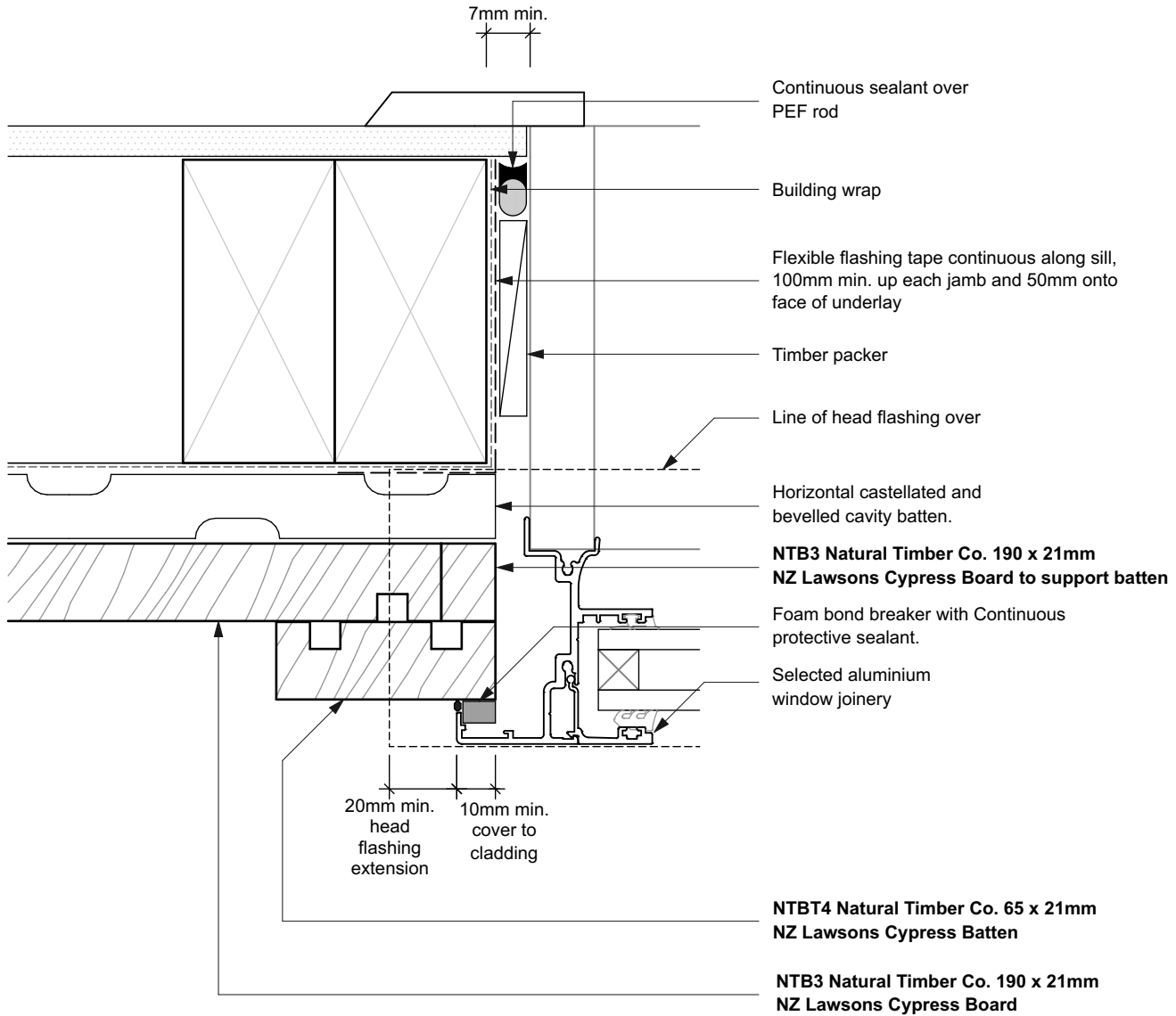

NOTES

- All nail fixings pre-drilled min. 1mm diameter smaller than the nail gauge.
- All NZ Natural Timber Co. timber products to be pre-coated and cut ends and edges and all fresh cut surfaces double coated and sealed before fixing.
- All corner flashings to be 75 x 75mm to suit all wind zones. All flashings to have hemmed edges to NZBC E2/AS1.
- Avoid contact in seaspray zones or corrosion zone D between CCA treated timber and metal flashings. Refer NZBC E2/AS1 Table 21

NT-LC.02 Board & Batten Weatherboard System. Cavity Fix		SCALE 1:2 @ A4
DRAWING Window Jamb Detail	05	

	SUSTAINABLE BESPOKE TIMBERS - COMMERCIAL & RESIDENTIAL		
	WWW.NZNATURALTIMBER.CO.NZ SALES@NZNATURALTIMBER.CO.NZ - PHONE 0800NZTIMBER	SHOWROOM 51 COMMERCE ST WHANGAREI 0110 NEW ZEALAND	

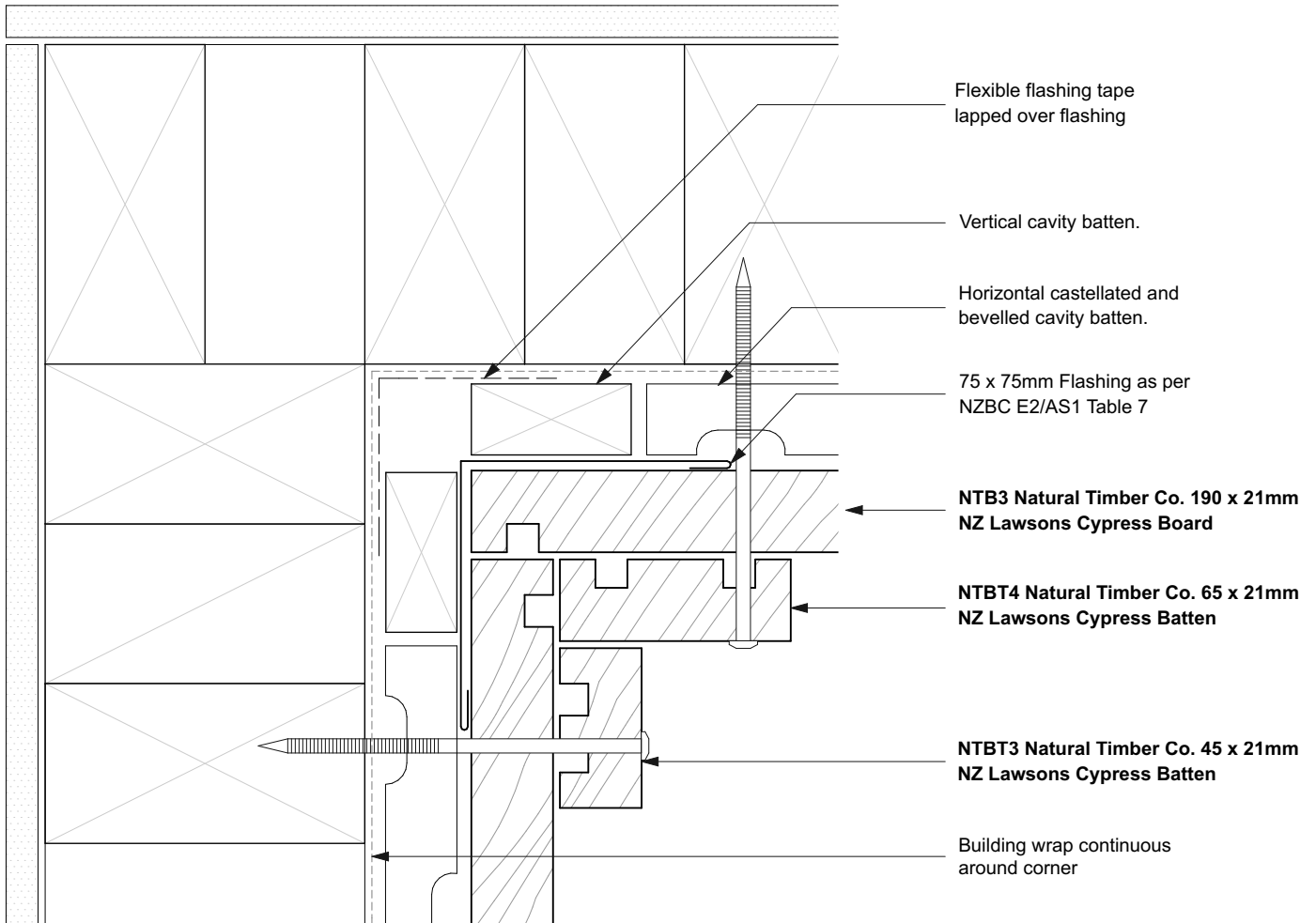

NOTES

- All nail fixings pre-drilled min. 1mm diameter smaller than the nail gauge.
- All NZ Natural Timber Co. timber products to be pre-coated and cut ends and edges and all fresh cut surfaces double coated and sealed before fixing.
- All corner flashings to be 75 x 75mm to suit all wind zones. All flashings to have hemmed edges to NZBC E2/AS1.
- Avoid contact in seaspray zones or corrosion zone D between CCA treated timber and metal flashings. Refer NZBC E2/AS1 Table 21

NT-LC.02 Board & Batten Weatherboard System. Cavity Fix		SCALE 1:2 @ A4
DRAWING	Internal Corner	06

	SUSTAINABLE BESPOKE TIMBERS - COMMERCIAL & RESIDENTIAL		
	WWW.NZNATURALTIMBER.CO.NZ SALES@NZNATURALTIMBER.CO.NZ - PHONE 0800NZTIMBER	SHOWROOM 51 COMMERCE ST WHANGAREI 0110 NEW ZEALAND	

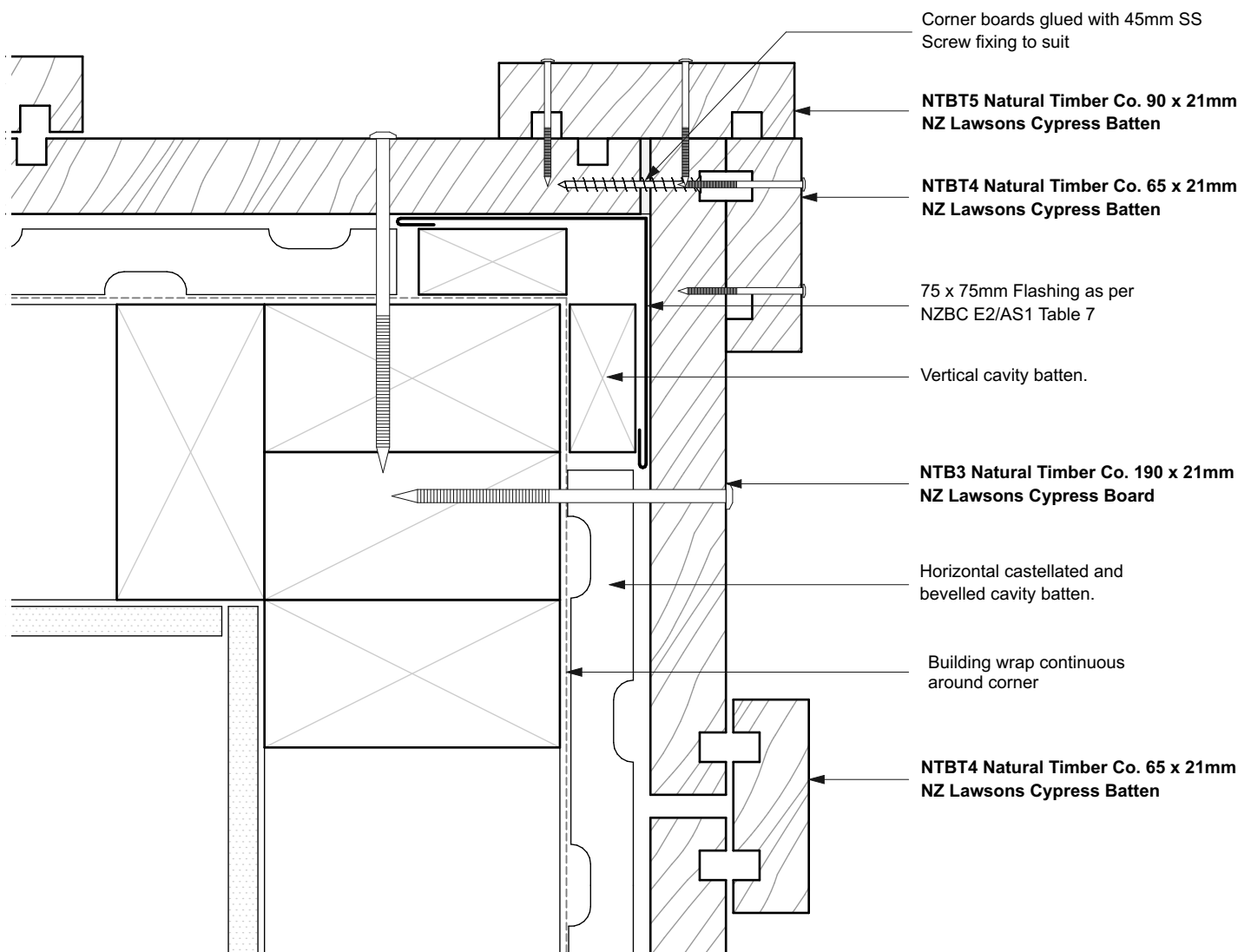

NOTES

- All nail fixings pre-drilled min. 1mm diameter smaller than the nail gauge.
- All NZ Natural Timber Co. timber products to be pre-coated and cut ends and edges and all fresh cut surfaces double coated and sealed before fixing.
- All corner flashings to be 75 x 75mm to suit all wind zones. All flashings to have hemmed edges to NZBC E2/AS1.
- Avoid contact in seaspray zones or corrosion zone D between CCA treated timber and metal flashings. Refer NZBC E2/AS1 Table 21

NT-LC.02 Board & Batten Weatherboard System. Cavity Fix		SCALE 1:2 @ A4
DRAWING	External Corner	07

	SUSTAINABLE BESPOKE TIMBERS - COMMERCIAL & RESIDENTIAL		 FULL SERVICE
	WWW.NZNATURALTIMBER.CO.NZ	SHOWROOM	
	SALES@NZNATURALTIMBER.CO.NZ	51 COMMERCE ST WHANGAREI 0110 NEW ZEALAND	
	PHONE 0800NZTIMBER		

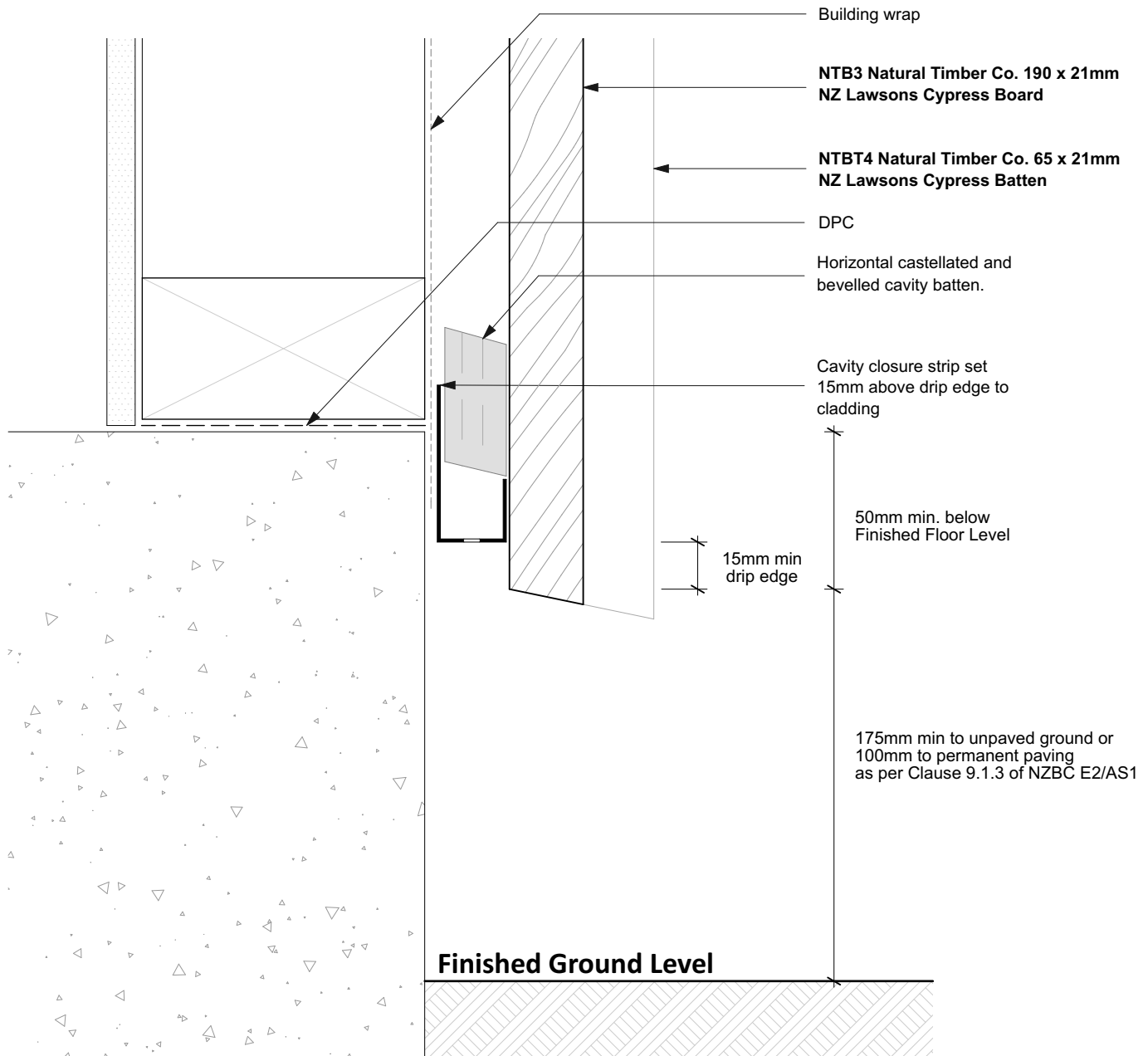

NOTES

- All nail fixings pre-drilled min. 1mm diameter smaller than the nail gauge.
- All NZ Natural Timber Co. timber products to be pre-coated and cut ends and edges and all fresh cut surfaces double coated and sealed before fixing.
- All corner flashings to be 75 x 75mm to suit all wind zones. All flashings to have hemmed edges to NZBC E2/AS1.
- Avoid contact in seaspray zones or corrosion zone D between CCA treated timber and metal flashings. Refer NZBC E2/AS1 Table 21

NT-LC.02 Board & Batten Weatherboard System. Cavity Fix		SCALE 1:2 @ A4
DRAWING Base of Wall - Concrete		08

	SUSTAINABLE BESPOKE TIMBERS - COMMERCIAL & RESIDENTIAL		
	WWW.NZNATURALTIMBER.CO.NZ SALES@NZNATURALTIMBER.CO.NZ - PHONE 0800NZTIMBER	SHOWROOM 51 COMMERCE ST WHANGAREI 0110 NEW ZEALAND	

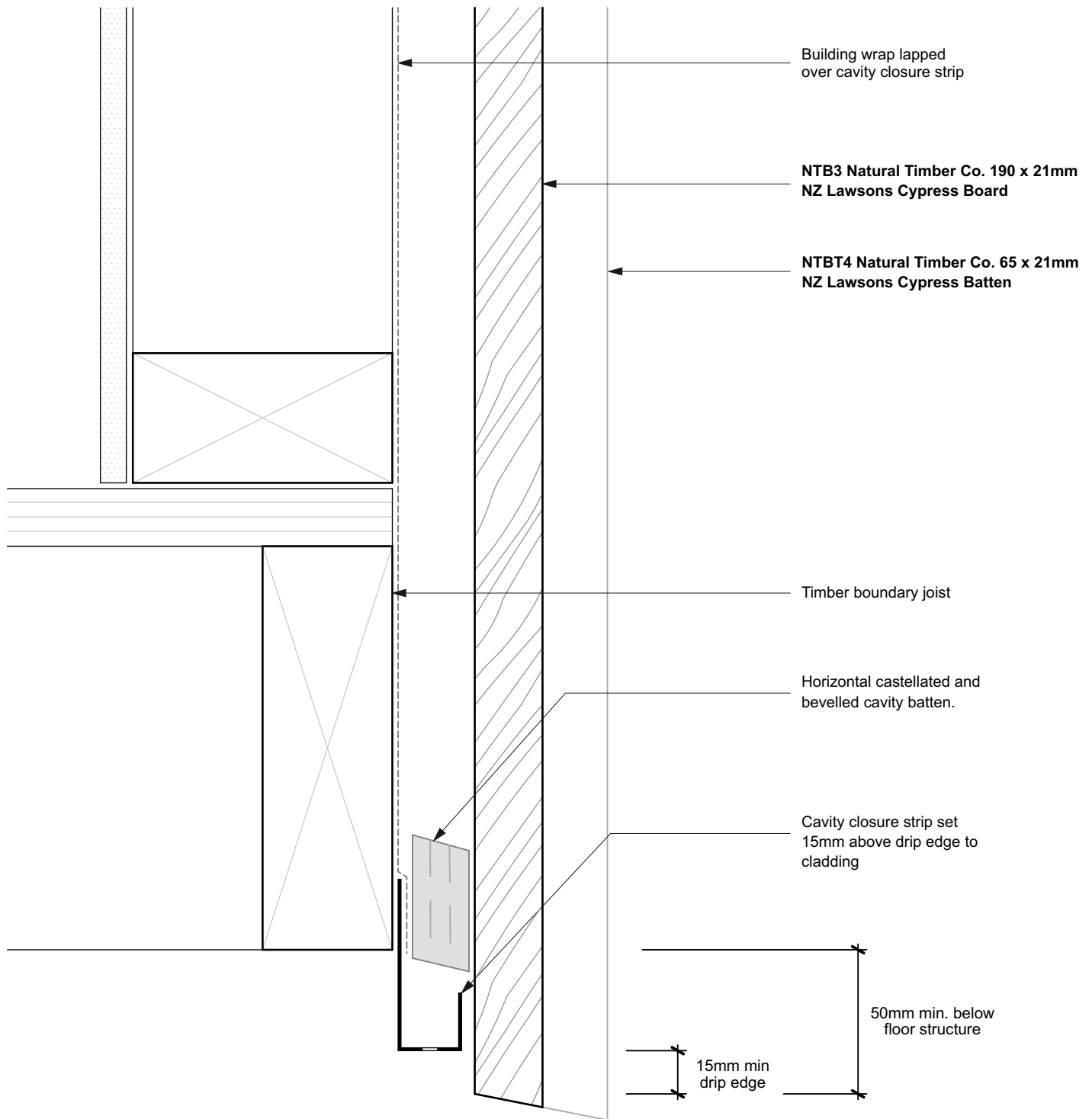

NOTES

- All nail fixings pre-drilled min. 1mm diameter smaller than the nail gauge.
- All NZ Natural Timber Co. timber products to be pre-coated and cut ends and edges and all fresh cut surfaces double coated and sealed before fixing.
- All corner flashings to be 75 x 75mm to suit all wind zones. All flashings to have hemmed edges to NZBC E2/AS1.
- Avoid contact in seaspray zones or corrosion zone D between CCA treated timber and metal flashings. Refer NZBC E2/AS1 Table 21

NT-LC.02 Board & Batten Weatherboard System. Cavity Fix		SCALE 1:2 @ A4
DRAWING Base of Wall - Timber	09	

	SUSTAINABLE BESPOKE TIMBERS - COMMERCIAL & RESIDENTIAL		
	WWW.NZNATURALTIMBER.CO.NZ SALES@NZNATURALTIMBER.CO.NZ - PHONE 0800NZTIMBER	SHOWROOM 51 COMMERCE ST WHANGAREI 0110 NEW ZEALAND	

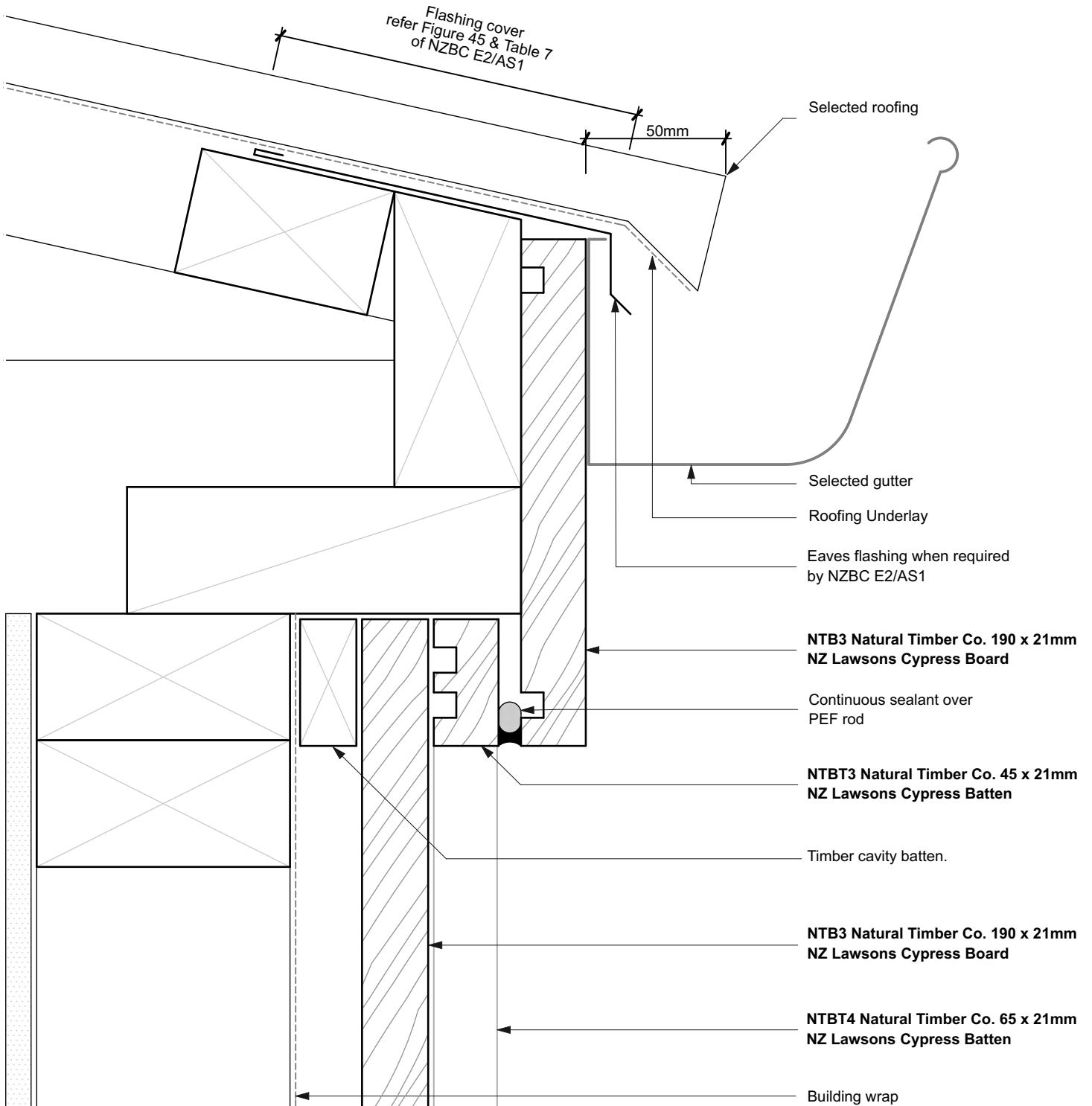

NOTES

- All nail fixings pre-drilled min. 1mm diameter smaller than the nail gauge.
- All NZ Natural Timber Co. timber products to be pre-coated and cut ends and edges and all fresh cut surfaces double coated and sealed before fixing.
- All corner flashings to be 75 x 75mm to suit all wind zones. All flashings to have hemmed edges to NZBC E2/AS1.
- Avoid contact in seaspray zones or corrosion zone D between CCA treated timber and metal flashings. Refer NZBC E2/AS1 Table 21

NT-LC.02 Board & Batten Weatherboard System. Cavity Fix		SCALE 1:2 @ A4
DRAWING	Eaves Detail	11

	SUSTAINABLE BESPOKE TIMBERS - COMMERCIAL & RESIDENTIAL		 FULL SERVICE
	WWW.NZNATURALTIMBER.CO.NZ SALES@NZNATURALTIMBER.CO.NZ - PHONE 0800NZTIMBER	SHOWROOM 51 COMMERCE ST WHANGAREI 0110 NEW ZEALAND	

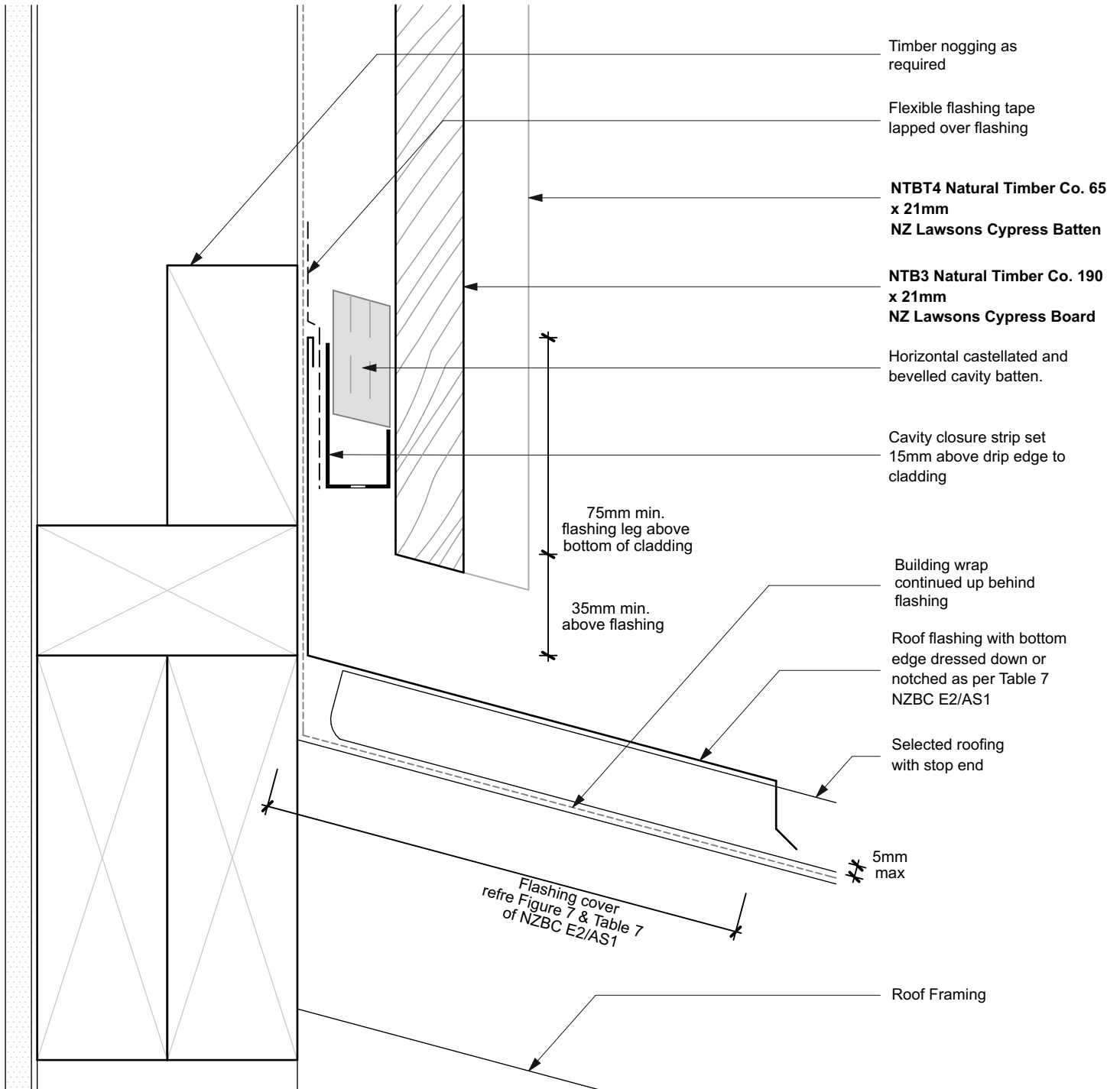

NOTES

- All nail fixings pre-drilled min. 1mm diameter smaller than the nail gauge.
- All NZ Natural Timber Co. timber products to be pre-coated and cut ends and edges and all fresh cut surfaces double coated and sealed before fixing.
- All corner flashings to be 75 x 75mm to suit all wind zones. All flashings to have hemmed edges to NZBC E2/AS1.
- Avoid contact in seaspray zones or corrosion zone D between CCA treated timber and metal flashings. Refer NZBC E2/AS1 Table 21

NT-LC.02 Board & Batten Weatherboard System. Cavity Fix		SCALE 1:2 @ A4
DRAWING Roof/Wall Junction Detail		12

	SUSTAINABLE BESPOKE TIMBERS - COMMERCIAL & RESIDENTIAL		
	WWW.NZNATURALTIMBER.CO.NZ SALES@NZNATURALTIMBER.CO.NZ - PHONE 0800NZTIMBER	SHOWROOM 51 COMMERCE ST WHANGAREI 0110 NEW ZEALAND	

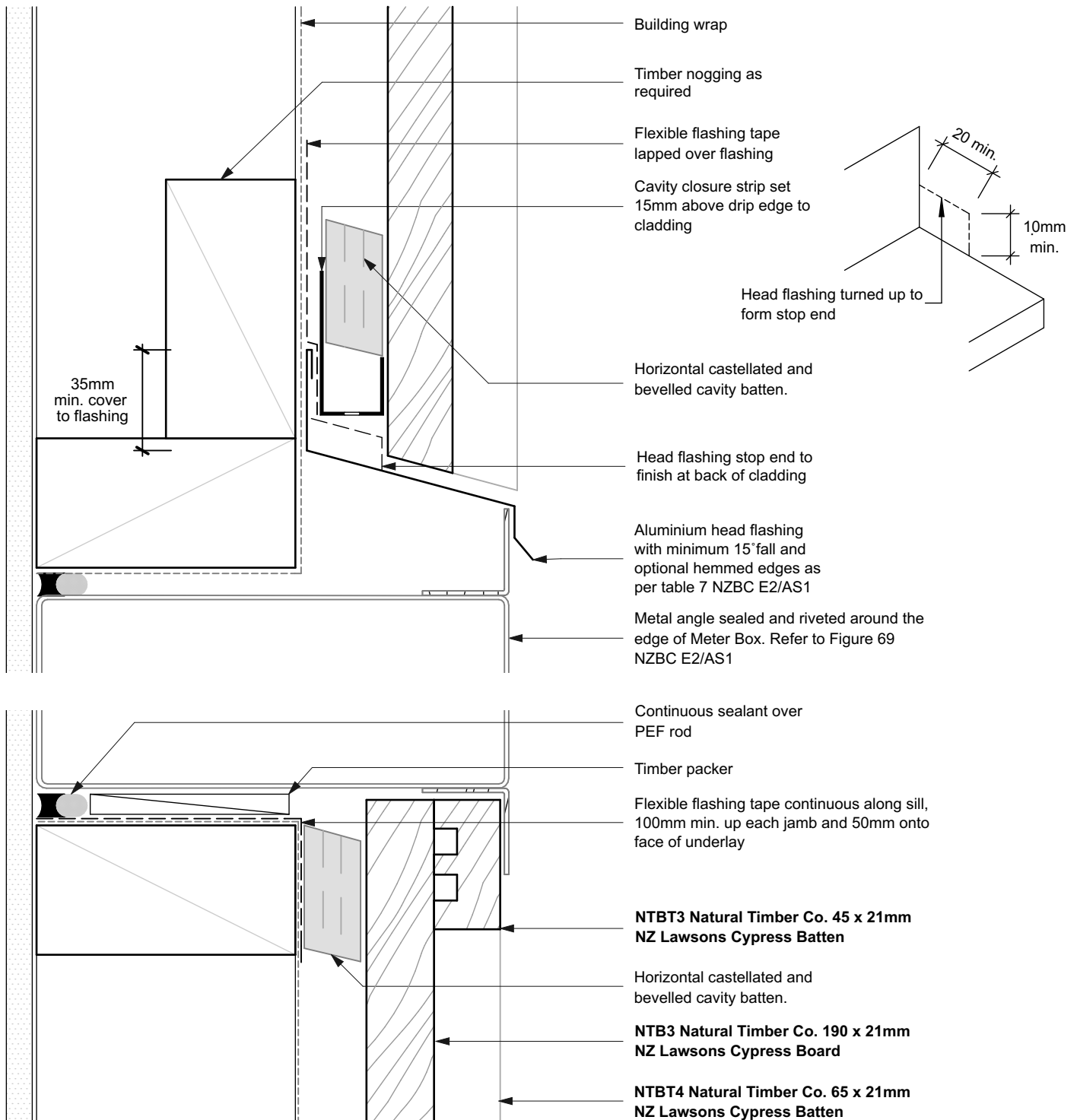

NOTES

- All nail fixings pre-drilled min. 1mm diameter smaller than the nail gauge.
- All NZ Natural Timber Co. timber products to be pre-coated and cut ends and edges and all fresh cut surfaces double coated and sealed before fixing.
- All corner flashings to be 75 x 75mm to suit all wind zones. All flashings to have hemmed edges to NZBC E2/AS1.
- Avoid contact in seaspray zones or corrosion zone D between CCA treated timber and metal flashings. Refer NZBC E2/AS1 Table 21

NT-LC.02 Board & Batten Weatherboard System. Cavity Fix		SCALE 1:2 @ A4
DRAWING	Meter Box Detail	13